



SUN2000-(150K-MG0-ZH, 150K-MG0) Quick Guide

EN

ZH



Scan for support

EN

ZH

EN Before installing the equipment, read the user manual carefully to get familiar with product information and safety precautions. The product warranty does not cover equipment damage caused by failure to follow the storage, transportation, installation, and usage guidelines specified in this document and the user manual. The information in this document is subject to change without notice. Every effort has been made in the preparation of this document to ensure accuracy of the contents, but all statements, information, and recommendations in this document do not constitute a warranty of any kind, express or implied.

ZH 安装设备前请详细阅读用户手册，了解产品信息及安全注意事项。未按照本文档与用户手册的内容存储、搬运、安装和使用设备而导致设备损坏，不在设备质保范围内。由于产品版本升级或其他原因，本文档内容会不定期进行更新。除非另有约定，本文档仅作为使用指导，文档中的所有陈述、信息和建议不构成任何明示或暗示的担保。

1

EN Installation Requirements

ZH 安装要求

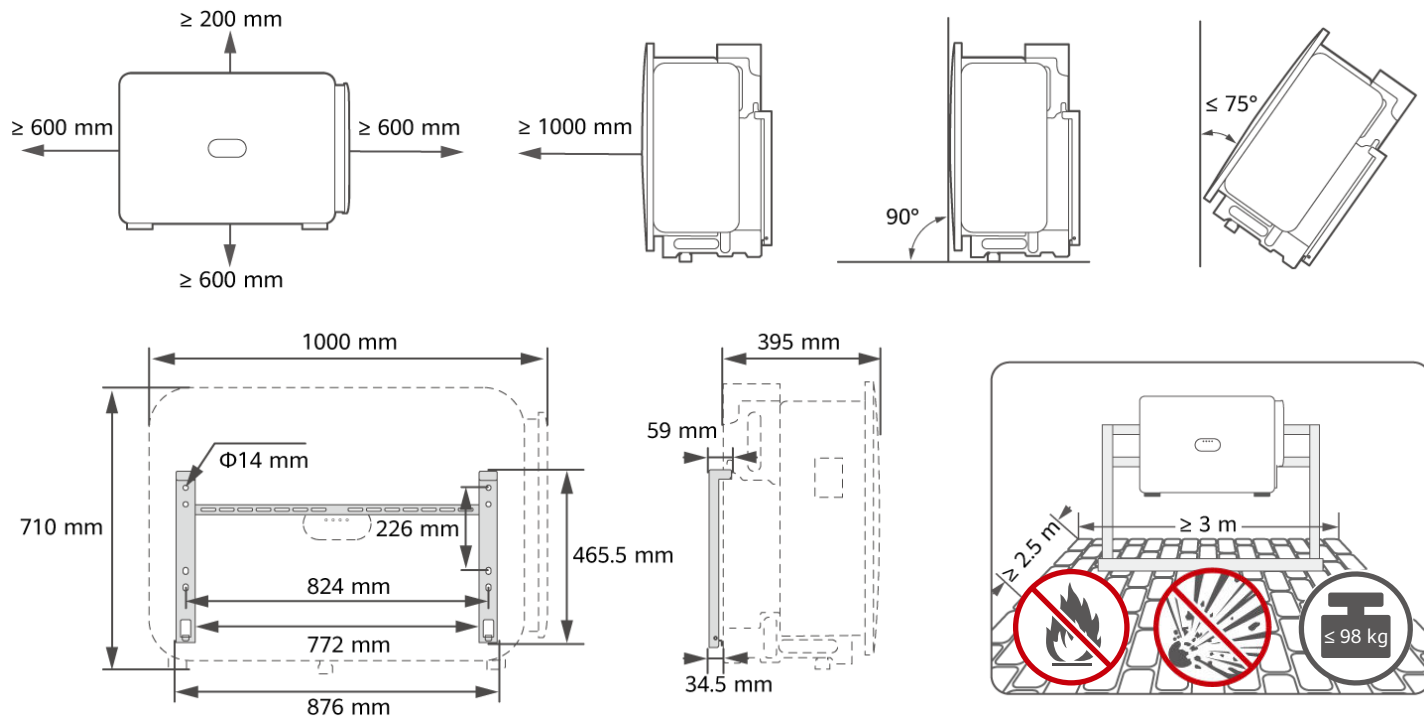

2

EN Installing the Device

ZH 安装设备

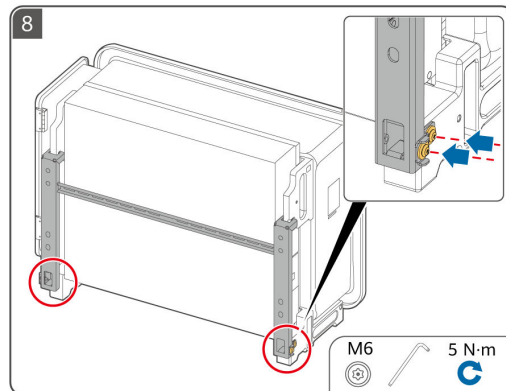
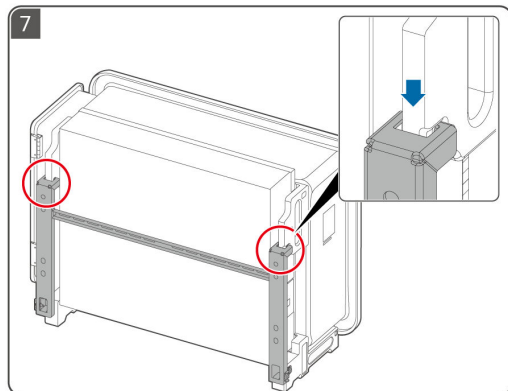
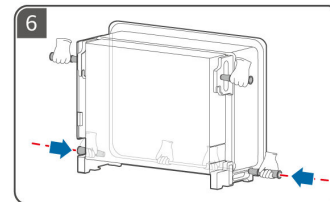
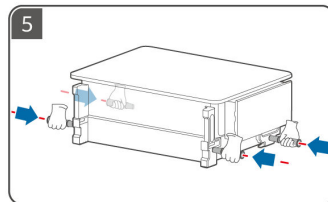
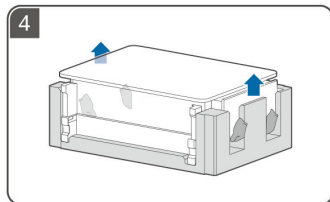
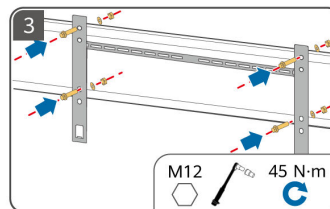
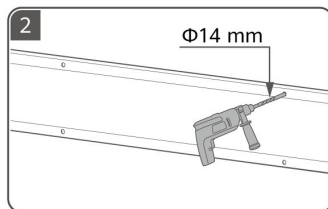
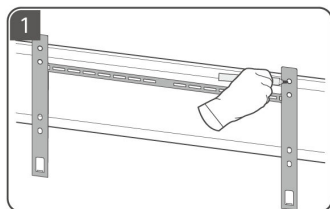

3

EN Preparing a PE Cable

ZH 准备保护地线

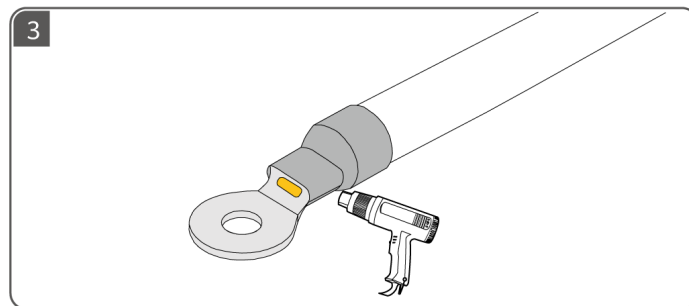
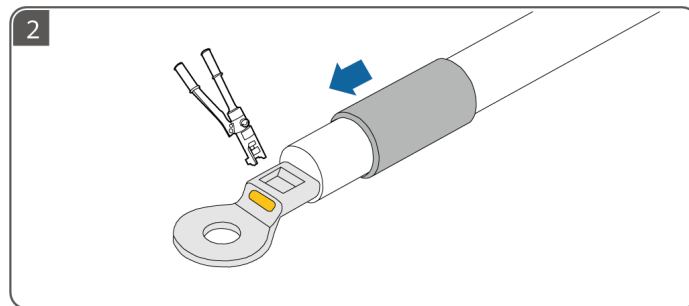
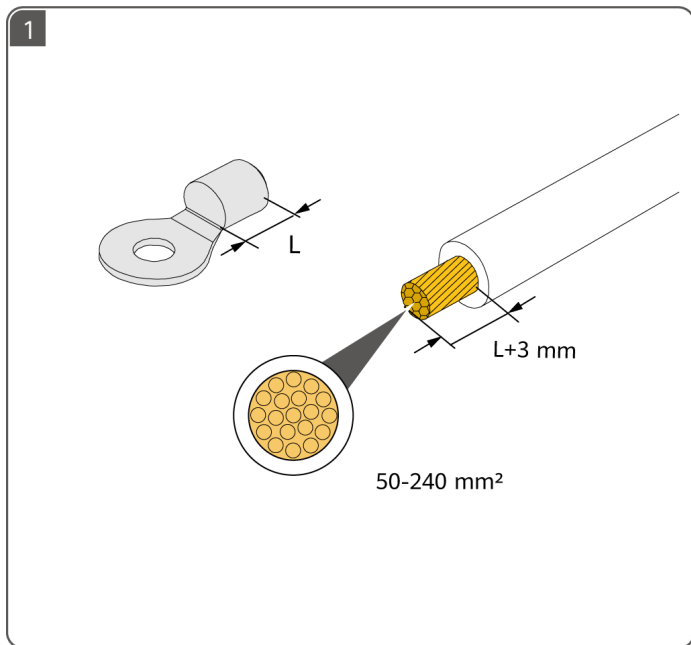

4

EN Preparing DC Cables

ZH 准备直流线缆

EN Use the PV connectors delivered with the inverter.

ZH 使用逆变器随箱配发的光伏连接器。

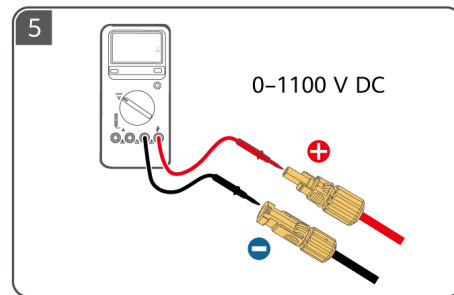
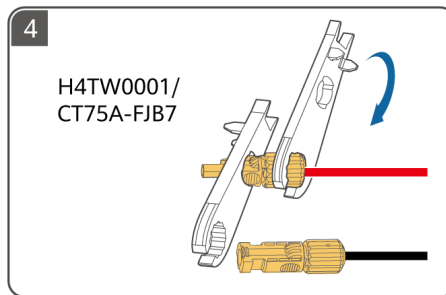
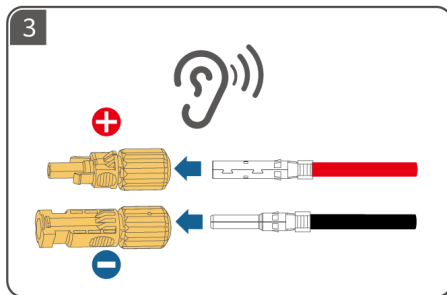
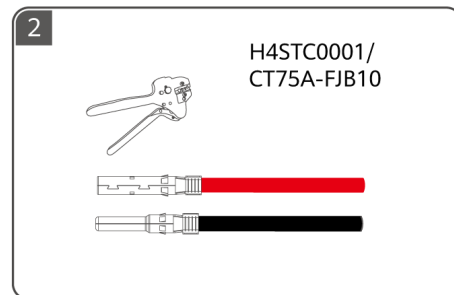
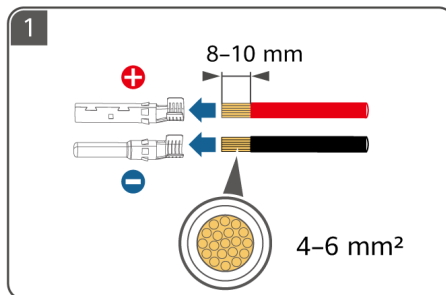
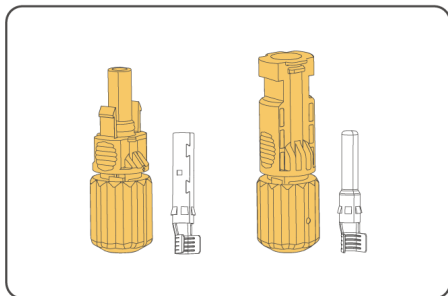

5

EN Preparing AC Cables

ZH 准备交流线缆



- EN** ① Do not connect loads between the inverter and the AC switch that directly connects to the inverter. Otherwise, the switch may trip by mistake. ② If an AC switch is used with specifications beyond local standards, regulations, or the Company's recommendations, the switch may fail to turn off in a timely manner in case of exceptions, causing serious faults. ③ Each inverter must be equipped with an AC output switch. Multiple inverters cannot connect to the same AC output switch.

- ZH** ① 禁止在逆变器和与逆变器直连的交流开关之间接入负载，避免引起开关误脱扣。② 未按当地标准、法规或本公司推荐值要求，采用过大规格交流开关，异常情况下可能无法及时安全断开，引发严重故障。③ 每台逆变器需配备一个交流输出开关，多台逆变器不可同时接入一个交流开关。

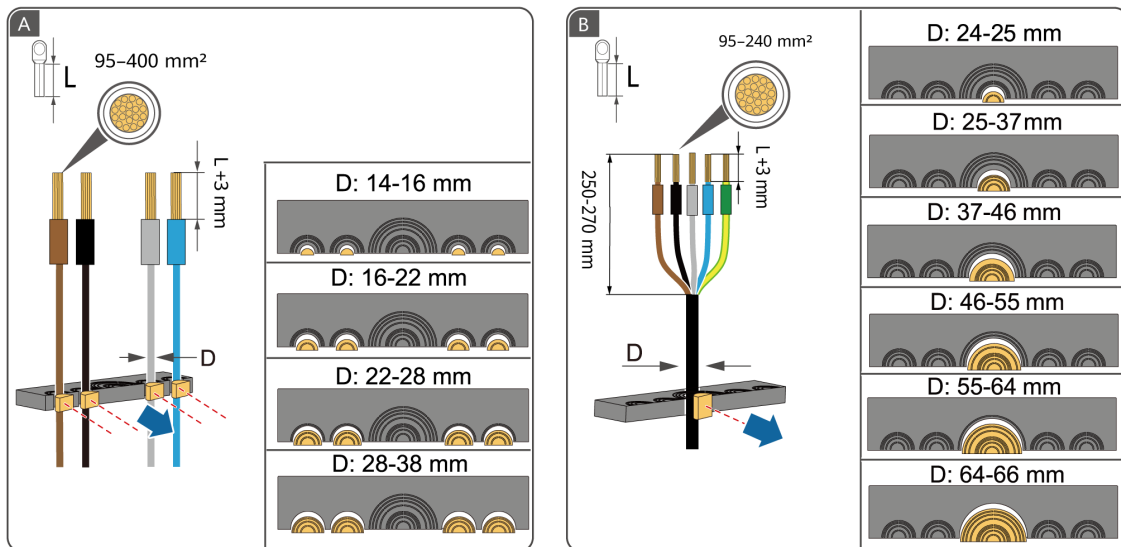

6

EN Preparing Signal Cables

ZH 准备信号线缆

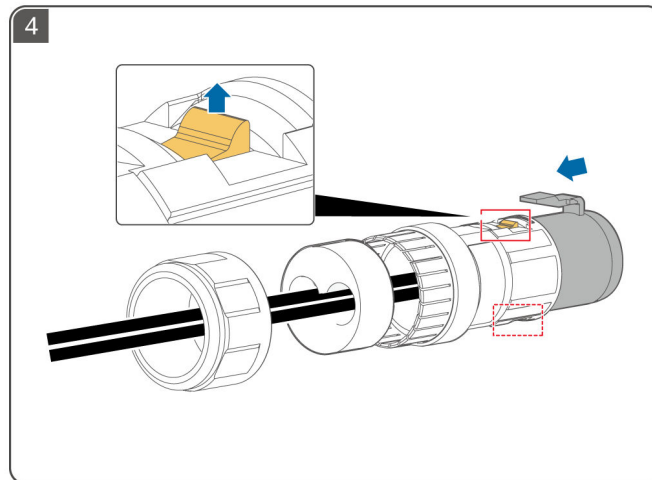
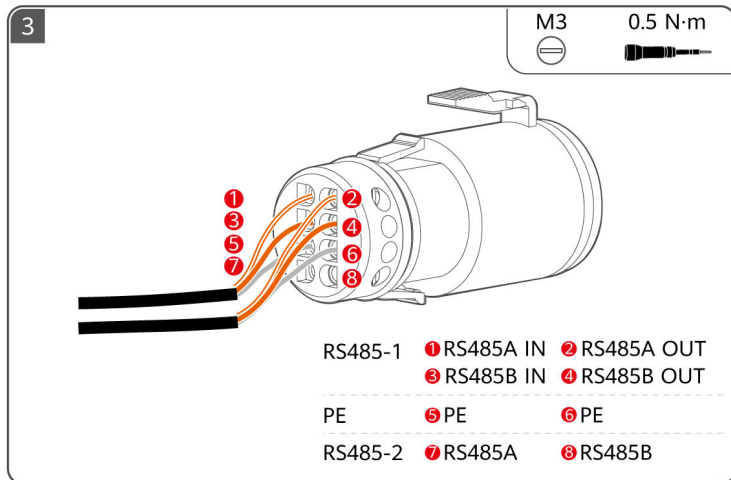
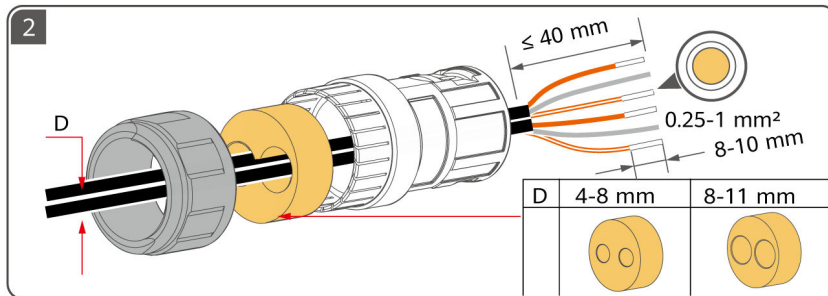
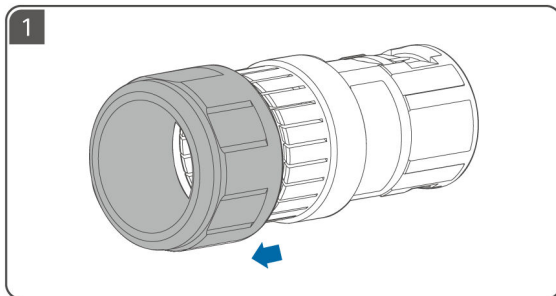

7

EN Electrical Connections

ZH 电气连接

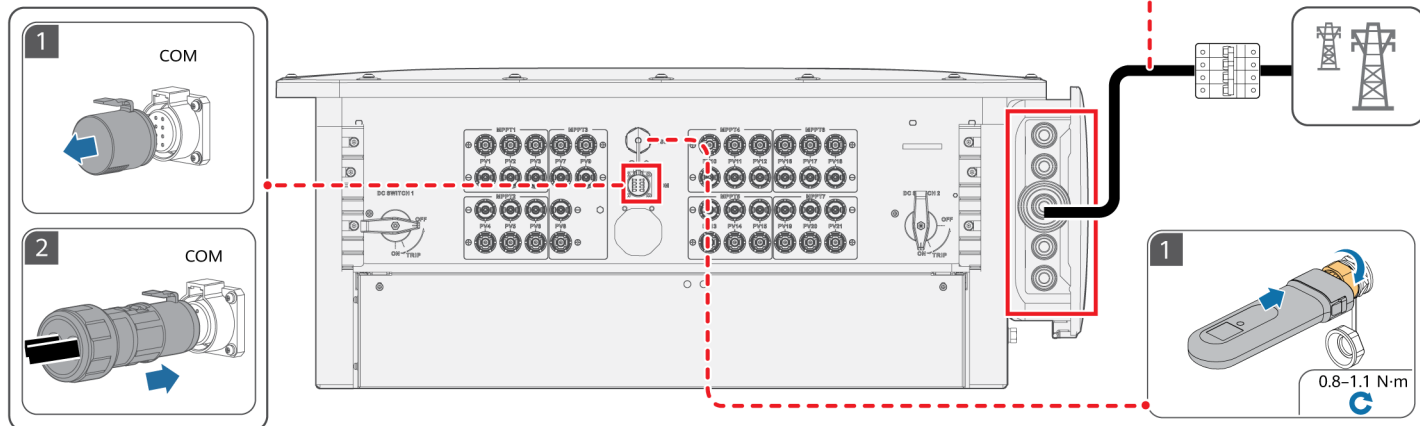
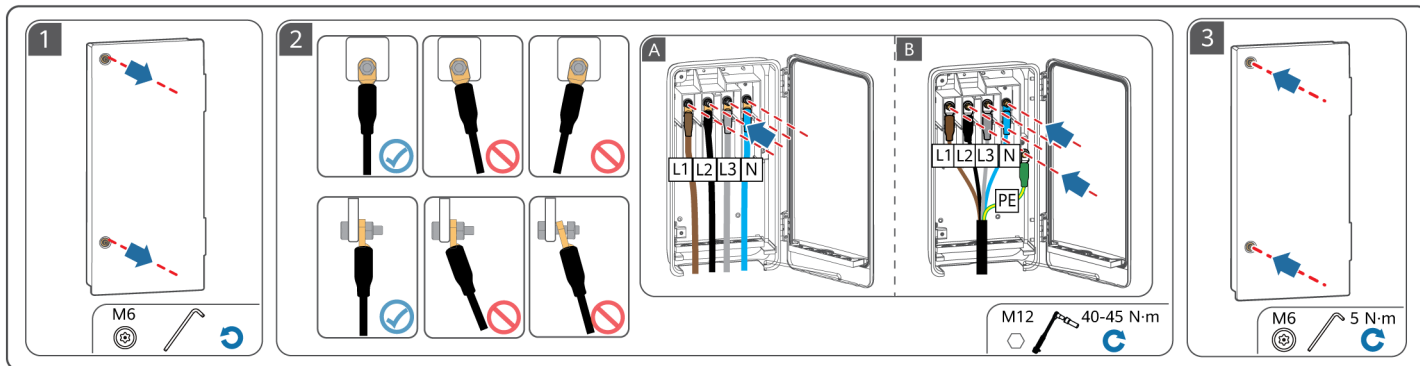

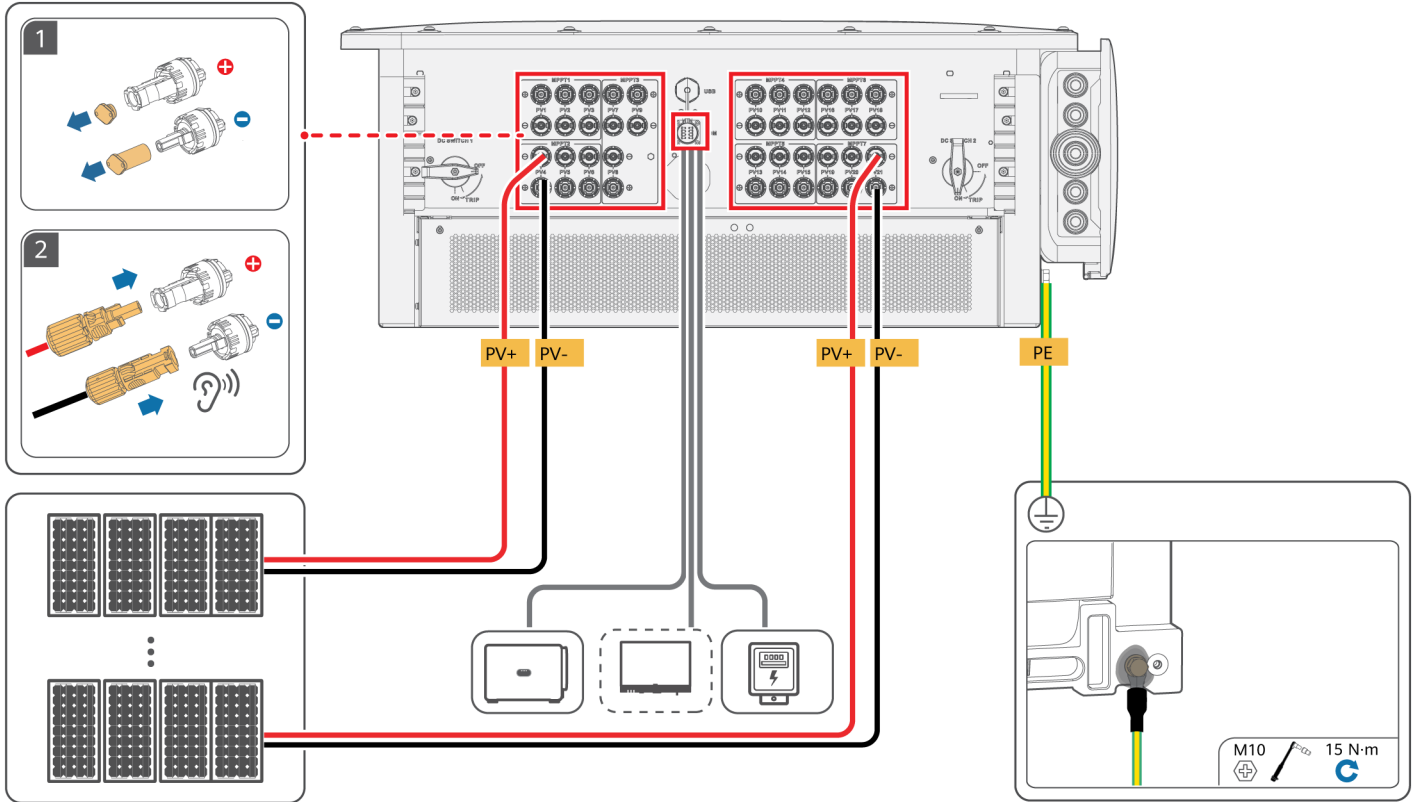

8

EN Power-On and Commissioning

ZH 上电调测

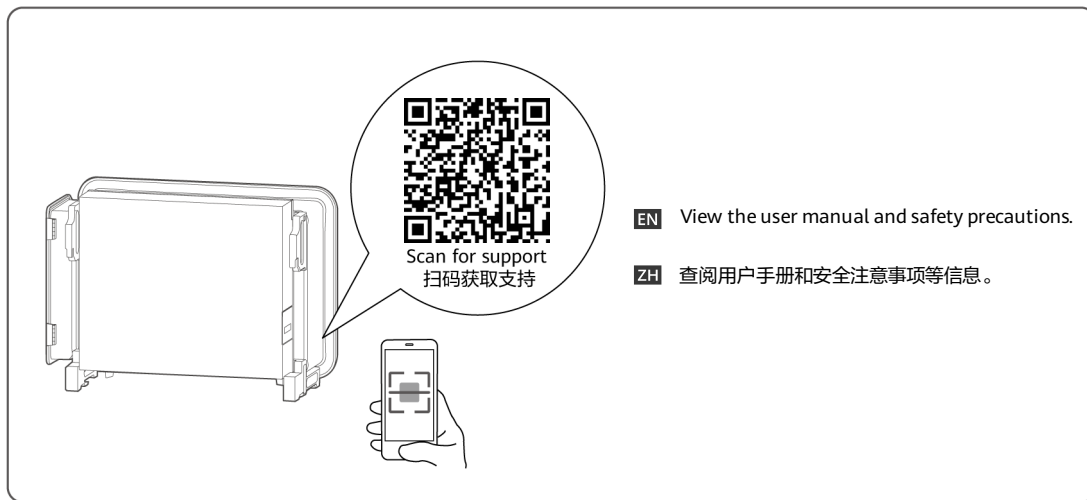
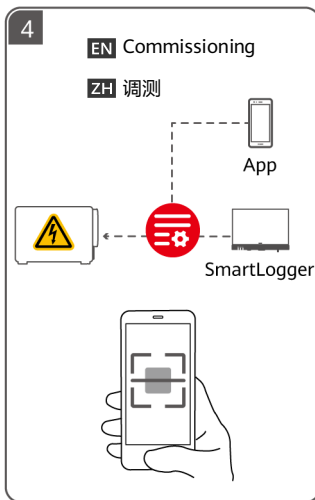
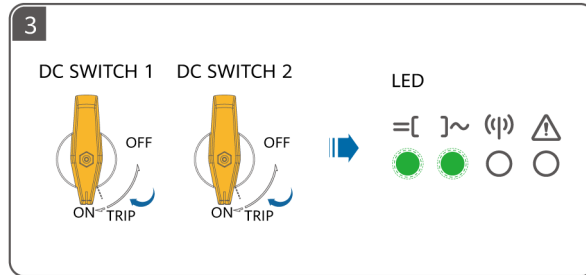
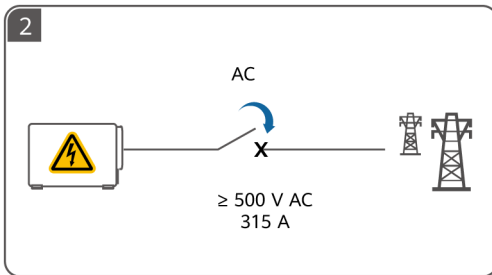
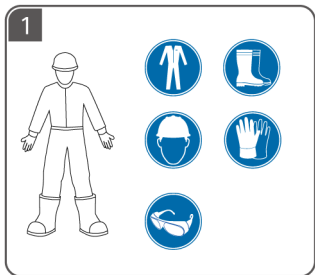



Copyright © Huawei Technologies Co., Ltd. 2024. All rights reserved.

Huawei Technologies Co., Ltd.

Huawei Industrial Base

Bantian, Longgang

Shenzhen 518129

People's Republic of China

<https://e.huawei.com>