



SUNNY TRIPOWER X 12 / 15 / 20 / 25

Legal Provisions

The information contained in these documents is the property of SMA Solar Technology AG. No part of this document may be reproduced, stored in a retrieval system, or transmitted, in any form or by any means, be it electronic, mechanical, photographic, magnetic or otherwise, without the prior written permission of SMA Solar Technology AG. Internal reproduction used solely for the purpose of product evaluation or other proper use is allowed and does not require prior approval.

SMA Solar Technology AG makes no representations or warranties, express or implied, with respect to this documentation or any of the equipment and/or software it may describe, including (with no limitation) any implied warranties of utility, merchantability, or fitness for any particular purpose. All such representations or warranties are expressly disclaimed. Neither SMA Solar Technology AG nor its distributors or dealers shall be liable for any indirect, incidental, or consequential damages under any circumstances.

The exclusion of implied warranties may not apply in all cases under some statutes, and thus the above exclusion may not apply.

Specifications are subject to change without notice. Every attempt has been made to make this document complete, accurate and up-to-date. Readers are cautioned, however, that product improvements and field usage experience may cause SMA Solar Technology AG to make changes to these specifications without advance notice or per contract provisions. SMA Solar Technology AG shall not be responsible for any damages, including indirect, incidental or consequential damages, caused by reliance on the material presented, including, but not limited to, omissions, typographical errors, arithmetical errors or listing errors in the content material.

SMA Warranty

You can download the current warranty conditions from the Internet at www.SMA-Solar.com.

Software licenses

The licenses for the installed software modules (open source) can be found in the user interface of the product.

Trademarks

All trademarks are recognized, even if not explicitly identified as such. Missing designations do not mean that a product or brand is not a registered trademark.

SMA Solar Technology AG

Sonnenallee 1

34266 Niestetal

Germany

Phone +49 561 9522-0

Fax +49 561 9522 100

www.SMA.de

E-mail: info@SMA.de

Status: 11/3/2022

Copyright © 2022 SMA Solar Technology AG. All rights reserved.

Table of Contents

1	Information on this Document.....	6
1.1	Validity	6
1.2	Target Group.....	6
1.3	Content and Structure of this Document	6
1.4	Levels of warning messages	6
1.5	Symbols in the Document	7
1.6	Typographical Elements in the Document.....	7
1.7	Designations in the Document	7
2	Safety	8
2.1	Intended Use	8
2.2	IMPORTANT SAFETY INSTRUCTIONS.....	9
3	Scope of Delivery	14
4	Product Overview	16
4.1	Product Description	16
4.2	Symbols on the Product	16
4.3	LED Signals	18
4.4	Interfaces and Functions	19
4.5	Device Configuration	21
4.6	System Overview	22
4.6.1	Sunny Tripower X as system manager.....	22
4.6.2	Sunny Tripower X with Sunny Home Manager 2.0	22
4.6.3	Sunny Tripower X with SMA Data Manager.....	23
5	Mounting	24
5.1	Requirements for Mounting	24
5.2	Mounting the product	26
6	Electrical Connection.....	29
6.1	Overview of the Connection Area	29
6.1.1	View from Below.....	29
6.1.2	Interior View	30
6.2	AC Connection.....	30
6.2.1	Requirements for the AC Connection	30
6.2.2	Connecting the Inverter to the Utility Grid.....	32
6.2.3	Connecting Additional Grounding	34
6.3	Connecting the Ripple Control Receiver.....	35
6.4	Connecting the Network Cables.....	38

6.5	Connection to the Multifunction Relay	39
6.6	Connecting Signal Source to Digital Input DI 5-6	41
6.7	DC Connection	43
6.7.1	Requirements for the DC Connection	43
6.7.2	Assembling the DC Connectors	44
6.7.3	Connecting the PV Array	46
6.7.4	Disassembling the DC Connectors	49
7	Commissioning	51
7.1	Commissioning Procedure	51
7.2	Commissioning the Product	51
7.3	Changing the Network Configuration	52
7.4	Configuring the Product	52
8	Operation	54
8.1	Establishing a connection to the user interface	54
8.1.1	Establishing a direct connection via WLAN	54
8.1.2	Establishing a Connection via Ethernet in the local network	55
8.1.3	Establishing a Connection via WLAN in the Local Network	56
8.2	Activate WPS Function	56
8.3	Speedwire Encryption of the System Communication	57
8.4	Activating or Deactivating SMA ArcFix	58
8.5	Creating a Backup File	58
8.6	Deleting the Admin Account	59
9	Disconnecting the Inverter from Voltage Sources	60
10	Clean the product	63
11	Troubleshooting	64
11.1	Event Messages	64
11.2	Checking the PV System for Ground Faults	84
11.3	Resetting the Operation Inhibition after Detection of an Arc Fault	88
12	Decommissioning the Inverter	89
13	Technical Data	90
14	Accessories	96
15	Contact	97
16	EU Declaration of Conformity	98

17 UK Declaration of Conformity 99

1 Information on this Document

1.1 Validity

This document is valid for:

- STP 12-50 (Sunny Tripower X 12)
- STP 15-50 (Sunny Tripower X 15)
- STP 20-50 (Sunny Tripower X 20)
- STP 25-50 (Sunny Tripower X 25)

1.2 Target Group

This document is intended for qualified persons and end users. Only qualified persons are allowed to perform the activities marked in this document with a warning symbol and the caption "Qualified person". Tasks that do not require any particular qualification are not marked and can also be performed by end users. Qualified persons must have the following skills:

- Knowledge of how an inverter works and is operated
- Training in how to deal with the dangers and risks associated with installing, repairing and using electrical devices and installations
- Training in the installation and commissioning of electrical devices and installations
- Knowledge of all applicable laws, standards and directives
- Knowledge of and compliance with this document and all safety information

1.3 Content and Structure of this Document

This document describes the mounting, installation, commissioning, configuration, operation, troubleshooting and decommissioning of the product as well as the operation of the product user interface.

You will find the latest version of this document and further information on the product in PDF format and as eManual at www.SMA-Solar.com. You can also call up the eManual via the user interface of the product.

Illustrations in this document are reduced to the essential information and may deviate from the real product.

1.4 Levels of warning messages

The following levels of warning messages may occur when handling the product.

DANGER

Indicates a hazardous situation which, if not avoided, will result in death or serious injury.

WARNING

Indicates a hazardous situation which, if not avoided, could result in death or serious injury.



⚠ CAUTION

Indicates a hazardous situation which, if not avoided, could result in minor or moderate injury.

NOTICE

Indicates a situation which, if not avoided, can result in property damage.

1.5 Symbols in the Document

Icon	Explanation
	Information that is important for a specific topic or goal, but is not safety-relevant
<input type="checkbox"/>	Indicates a requirement for meeting a specific goal
<input checked="" type="checkbox"/>	Desired result
	Example

 **QUALIFIED PERSON** Sections describing activities to be performed by qualified persons only

1.6 Typographical Elements in the Document

Typographical element	Use	Example
bold	<ul style="list-style-type: none"> Messages Terminals Elements on a user interface Elements to be selected Elements to be entered 	<ul style="list-style-type: none"> Connect the insulated conductors to the terminals X703:1 to X703:6. Enter 10 in the field Minutes.
>	<ul style="list-style-type: none"> Connects several elements to be selected 	<ul style="list-style-type: none"> Go to Settings > Date.
[Button] [Key]	<ul style="list-style-type: none"> Button or key to be clicked on or pressed down 	<ul style="list-style-type: none"> Select [Enter].
#	<ul style="list-style-type: none"> Placeholder for variable components (e.g., parameter names) 	<ul style="list-style-type: none"> Parameter WCtHz.Hz#

1.7 Designations in the Document

Complete designation	Designation in this document
Sunny Tripower	Inverter, product

2 Safety

2.1 Intended Use

The Sunny Tripower is a transformerless PV inverter, with 3 MPP trackers, that converts the direct current of the PV array to grid-compliant, three-phase current and feeds it into the utility grid.

The product is intended for use in residential and industrial environments.

The product complies with EN 55011 of class B, group 1.

The product is suitable for indoor and outdoor use.

The product must only be operated with PV modules of protection class II in accordance with IEC 61730, application class A. The PV modules must be compatible with this product.

If the product is operated with a medium-voltage transformer, the low-voltage side must be configured in a star formation and the neutral point grounded (for information about the requirements of the medium-voltage transformer, consult the technical information "Important Requirements for Medium-Voltage Transformers" under www.SMA-Solar.com).

The product is not equipped with an integrated transformer and therefore has no galvanic isolation. The product must not be operated with PV modules whose outputs are grounded. This can cause the product to be destroyed. The product may be operated with PV modules whose frame is grounded.

PV modules with a high capacity to ground must only be used if the coupling capacity of all PV modules does not exceed $6 \mu\text{F}$ (for information on how to determine the coupling capacity, see the Technical Information "Leading Leakage Currents" at www.SMA-Solar.com).

All components must remain within their permitted operating ranges and their installation requirements at all times.

The product must only be used in countries for which it is approved or released by SMA Solar Technology AG and the grid operator.

Use SMA products only in accordance with the information provided in the enclosed documentation and with the locally applicable laws, regulations, standards and directives. Any other application may cause personal injury or property damage.

Alterations to SMA products, e.g., changes or modifications, are only permitted with the express written permission of and according to the instructions from SMA Solar Technology AG. Unauthorized alterations can be dangerous and lead to personal injury. In addition, an unauthorized alteration will void guarantee and warranty claims and in most cases terminate the operating license. SMA Solar Technology AG shall not be held liable for any damage caused by such changes.

Any use of the product other than that described in the Intended Use section does not qualify as appropriate.

The enclosed documentation is an integral part of this product. Keep the documentation in a convenient, dry place for future reference and observe all instructions contained therein.

This document does not replace any regional, state, provincial, federal or national laws, regulations or standards that apply to the installation, electrical safety and use of the product. SMA Solar Technology AG assumes no responsibility for the compliance or non-compliance with such laws or codes in connection with the installation of the product.

The type label must remain permanently attached to the product.

2.2 IMPORTANT SAFETY INSTRUCTIONS

Keep the manual for future reference.

This section contains safety information that must be observed at all times when working.

The product has been designed and tested in accordance with international safety requirements. As with all electrical or electronic devices, there are residual risks despite careful construction. To prevent personal injury and property damage and to ensure long-term operation of the product, read this section carefully and observe all safety information at all times.

DANGER

Danger to life due to electric shock when live components or DC cables are touched

When exposed to light, the PV modules generate high DC voltage which is present in the DC cables. Touching live DC cables results in death or lethal injuries due to electric shock.

- Do not touch non-insulated parts or cables.
- Disconnect the product from voltage sources and ensure it cannot be reconnected before working on the device.
- Do not disconnect the DC connectors under load.
- Wear suitable personal protective equipment for all work on the product.

DANGER

Danger to life due to electric shock from touching an ungrounded PV module or array frame

Touching ungrounded PV modules or array frames results in death or lethal injuries due to electric shock.

- Connect and ground the frame of the PV modules, the array frame and the electrically conductive surfaces so that there is continuous conduction. Observe the applicable local regulations.

DANGER

Danger to life due to electric shock when touching live system components in case of a ground fault

If a ground fault occurs, parts of the system may still be live. Touching live parts and cables results in death or lethal injuries due to electric shock.

- Disconnect the product from voltage sources and ensure it cannot be reconnected before working on the device.
- Only touch the cables of the PV modules on their insulation.
- Do not touch any parts of the substructure or frame of the PV array.
- Do not connect PV strings with ground faults to the inverter.

DANGER

Danger to life due to electric shock in case of overvoltages and if surge protection is missing

Overvoltages (e. g. in the event of a flash of lightning) can be further conducted into the building and to other connected devices in the same network via the network cables or other data cables if there is no surge protection. Touching live parts and cables results in death or lethal injuries due to electric shock.

- Ensure that all devices in the same network are integrated in the existing overvoltage protection.
- When laying the network cable outdoors, ensure that there is suitable surge protection at the network cable transition from the product outdoors to the network inside the building.
- The Ethernet interface of the product is classified as "TNV-1" and offers protection against overvoltages of up to 1.5 kV.

WARNING

Danger to life due to fire and explosion

In rare cases, an explosive gas mixture can be generated inside the product under fault conditions. In this state, switching operations can cause a fire inside the product or explosion. Death or lethal injuries due to hot or flying debris can result.

- In the event of a fault, do not perform any direct actions on the product.
- Ensure that unauthorized persons have no access to the product.
- Do not operate the DC load-break switch on the inverter in case of an error.
- Disconnect the PV array from the inverter via an external disconnection device. If there is no disconnecting device present, wait until no more DC power is applied to the inverter.
- Disconnect the AC circuit breaker, or keep it disconnected in case it has already tripped, and secure it against reconnection.
- Only perform work on the product (e.g., troubleshooting, repair work) when wearing personal protective equipment for handling of hazardous substances (e.g., safety gloves, eye and face protection, respiratory protection).

WARNING

Risk of injury due to toxic substances, gases and dusts.

In rare cases, damages to electronic components can result in the formation of toxic substances, gases or dusts inside the product. Touching toxic substances and inhaling toxic gases and dusts can cause skin irritation, burns or poisoning, trouble breathing and nausea.

- Only perform work on the product (e.g., troubleshooting, repair work) when wearing personal protective equipment for handling of hazardous substances (e.g., safety gloves, eye and face protection, respiratory protection).
- Ensure that unauthorized persons have no access to the product.

⚠ WARNING**Danger to life due to electric shock from destruction of the measuring device due to overvoltage**

Overvoltage can damage a measuring device and result in voltage being present in the enclosure of the measuring device. Touching the live enclosure of the measuring device results in death or lethal injuries due to electric shock.

- Only use measuring devices with a DC input voltage range of 1000 V or higher.

⚠ CAUTION**Risk of burns due to hot enclosure parts**

The enclosure and the enclosure lid may get hot during operation. The DC load-break switch can not become hot.

- Do not touch hot surfaces.
- Wait until the inverter has cooled down before touching the enclosure or enclosure lid.

⚠ CAUTION**Risk of injury due to weight of product**

Injuries may result if the product is lifted incorrectly or dropped while being transported or mounted.

- Transport and lift the product carefully. Take the weight of the product into account.
- Use the carrying handles or hoist when transporting the product. To attach the hoist system, eye bolts must be screwed into the threads provided, which are located on the right and left of the product's mounting lugs.
- Wear suitable personal protective equipment for all work on the product.

NOTICE**Damage to the enclosure seal in subfreezing conditions**

If you open the product when temperatures are below freezing, the enclosure seals can be damaged. Moisture can penetrate the product and damage it.

- Only open the product if the ambient temperature is not below -5°C .
- If a layer of ice has formed on the enclosure seal when temperatures are below freezing, remove it prior to opening the product (e.g. by melting the ice with warm air).

NOTICE**Damage to the product due to sand, dust and moisture ingress**

Sand, dust and moisture penetration can damage the product and impair its functionality.

- Only open the product if the humidity is within the thresholds and the environment is free of sand and dust.
- Do not open the product during a dust storm or precipitation.
- Close tightly all enclosure openings.

NOTICE

Damage to the inverter due to electrostatic discharge

Touching electronic components can cause damage to or destroy the inverter through electrostatic discharge.

- Ground yourself before touching any component.

NOTICE

Manipulation of system data in networks

You can connect the supported SMA products to the Internet. When connected to the Internet, there is a risk that unauthorized users can access and manipulate the data of your system.

- Set up a firewall.
- Close unnecessary network ports.
- If absolutely necessary, only enable remote access via a virtual private network (VPN).
- Do not use the port forwarding feature. This also applies to the used Modbus ports.
- Disconnect system components from other network components (network segmentation).

NOTICE

High costs due to inappropriate Internet tariff

Depending on use, the data volume of the product transferred via the Internet may vary in size. The data volume depends, for example, on the number of devices in the system, the frequency of device updates, the frequency of data transfer to Sunny Portal or the use of FTP push. High costs for the Internet connection can be the result.

- SMA Solar Technology AG recommends using an Internet flat rate.

NOTICE

Damage to the product due to cleaning agents

The use of cleaning agents may cause damage to the product and its components.

- Clean the product and all its components only with a cloth moistened with clear water.

i DHCP Server is recommended.

The DHCP server automatically assigns the appropriate network settings to your nodes in the local network. A manual network configuration is therefore not necessary. In a local network, the Internet router is usually the DHCP server. If the IP addresses in the local network are to be assigned dynamically, DHCP must be activated in the Internet router (see the Internet router manual). In order to receive the same IP address by the internet router after a restart, set the MAC address binding.

In networks where no DHCP server is active, proper IP addresses must be assigned from the free address pool of the network segment to all network participants to be integrated during commissioning.

i A country data set must be set for feed-in operation

To ensure the inverter begins feed-in operation during initial commissioning, a country data set must be set (for instance via the installation assistant on the user interface of the product, or via a communication product).

If no country data set is set, then feed-in operation will be stopped. This state is signaled by the green and red LEDs flashing simultaneously.

The inverter will automatically start feed-in operation only after the inverter configuration is completed.

i The country data set must be set correctly.

If you select a country data set which is not valid for your country and purpose, it can cause a disturbance in the PV system and lead to problems with the grid operator. When selecting the country data set, you must always observe the locally applicable standards and directives as well as the properties of the PV system (e.g. PV system size, grid-connection point).

- If you are not sure which standards and directives are valid for your country or purpose, contact the grid operator.

3 Scope of Delivery

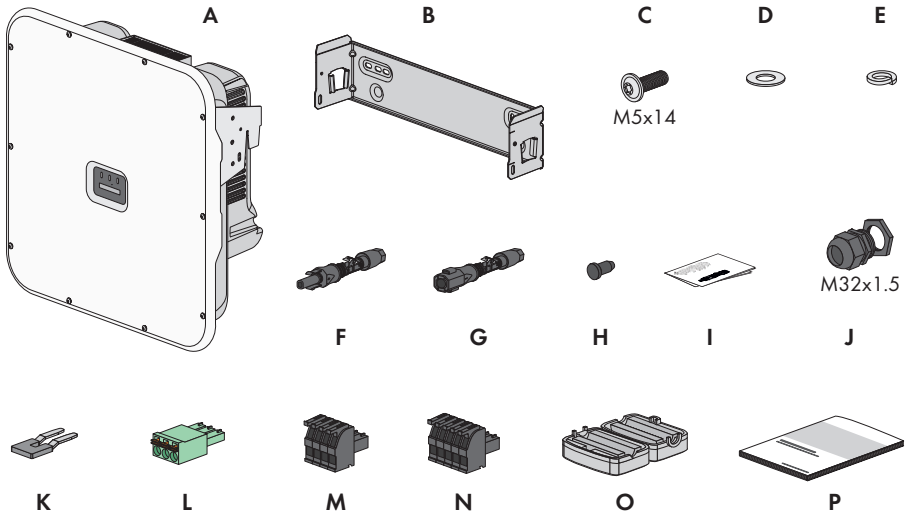

Figure 1: Components included in scope of delivery

Position	Quantity	Designation
A	1	Inverter
B	1	Wall mounting bracket
C	3	Bolt M5 x 14
D	1	Washer
E	1	Conical spring washer
F	6	Positive DC connector
G	6	Negative DC connector
H	12	Sealing plug for DC connectors
I	1	Operating manual for DC connectors
J	1	Cable gland M32x1.5 with counter nut
K	1	Jumper
L	1	3-pole terminal block
M	1	4-pole terminal block
N	1	5-pole terminal block

Position	Quantity	Designation
O	2	Ferrite for network port
P	1	<p>Quick reference guide with password label on the rear side</p> <p>The label contains the following information:</p> <ul style="list-style-type: none">• PIC (Product Identification Code) identification key for registering the system in Sunny Portal• RID (Registration Identifier) registration ID for registering the system in Sunny Portal• Wi-Fi password WPA2-PSK (WiFi Protected Access 2 - Preshared Key) for direct connection to the product via Wi-Fi• Device Key (DEV KEY) for resetting the administrator password

4 Product Overview

4.1 Product Description

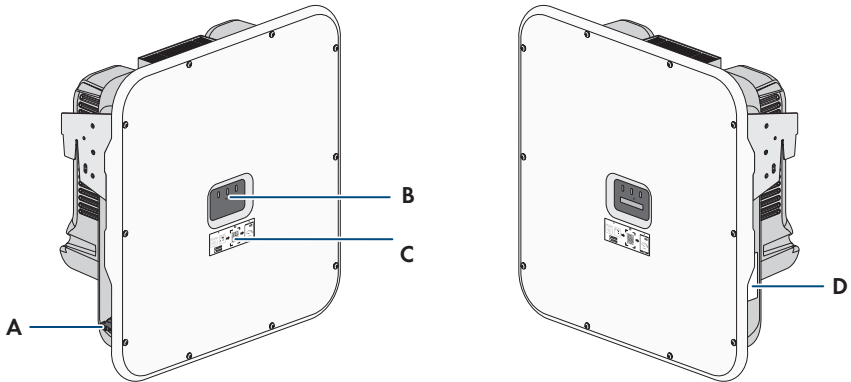















Figure 2: Design of the product

Position	Designation
A	DC load-break switch
B	LEDs The LEDs indicate the operating state of the product.
C	A label with a QR code to be scanned using the SMA apps
D	Type label The type label clearly identifies the product. The type label must remain permanently attached to the product. You will find the following information on the type label: <ul style="list-style-type: none"> • Device type (Model) • Serial number (Serial No. or S/N) • Date of manufacture • Device-specific characteristics

4.2 Symbols on the Product

Icon	Explanation
	Beware of a danger zone This symbol indicates that the product must be additionally grounded if additional grounding or equipotential bonding is required at the installation site.

Icon	Explanation
	Beware of electrical voltage The product operates at high voltages.
	Beware of hot surface The product can get hot during operation.
	Observe the documentations Observe all documentations supplied with the product.
	Inverter Together with the green LED, this symbol indicates the operating state of the inverter.
	Observe the documentations Together with the red LED, this symbol indicates an error.
	Data transmission Together with the blue LED, this symbol indicates the status of the network connection.
	Grounding This symbol indicates the position for the connection of an additional grounding conductor.
	Three-phase alternating current with neutral conductor
	Direct current
	The product has no galvanic isolation.
	WEEE designation Do not dispose of the product together with the household waste but in accordance with the disposal regulations for electronic waste applicable at the installation site.
	The product is suitable for outdoor installation.

Icon	Explanation
IP65	Degree of protection IP65 The product is protected against the penetration of dust and water that is directed as a jet against the enclosure from all directions.
CE	CE marking The product complies with the requirements of the applicable EU directives.
UK CA	UKCA marking The product complies with the regulations of the applicable laws of England, Wales and Scotland.
	RoHS labeling The product complies with the requirements of the applicable EU directives.

4.3 LED Signals

The LEDs indicate the operating state of the product.

LED signal	Explanation
Green LED and red LED flash simultaneously (2 s on and 2 s off)	No country data set set Operation of the product is stopped because no country data set is set. Once the configuration has been completed (for instance using the installation assistant or via a communication product), the product will start operation automatically.
The green LED is flashing (two seconds on and two seconds off)	Waiting for feed-in conditions The conditions for feed-in operation are not yet met. As soon as the conditions are met, the inverter will start feed-in operation.
The green LED is glowing	Feed-in operation The inverter is feeding in.
The green LED is off	No voltage is applied to the PV system.
The red LED is glowing	Error Inverter operation has been stopped. In addition, a distinct event message and the corresponding event number will be displayed on the product user interface or in the communication product (e.g. SMA Data Manager).
Red LED is flashing (0.25 s on, 0.25 s off, 0.25 s on, 1.25 s off)	Warning Communication with a higher-level plant controller has failed. The inverter continues to operate with restricted function (e.g. with set fallback level). In addition, a distinct event message and the corresponding event number will be displayed on the product user interface or in the communication product (e.g. SMA Data Manager).

LED signal	Explanation
Blue LED is flashing (2 s on and 2 s off)	Communication connection is being established The product is establishing a connection to a local network or is establishing a direct connection to a smart device via Ethernet (e.g. smartphone, tablet or laptop).
The blue LED is flashing fast (0.25 s on and 0.25 s off)	A communication product requests identification of the inverter.
The blue LED is glowing	There is an active connection with a local network (LAN/Wi-Fi) or there is a direct connection (Ethernet/WPS function) with a smart end device (e.g. smartphone, tablet or laptop).
Blue LED is off	There is no active connection.
All 3 LEDs are on	Inverter update or booting procedure

4.4 Interfaces and Functions

The inverter can be equipped or retrofitted with the following interfaces and functions:

Sunny Tripower X as System Manager

The Sunny Tripower X can be used as System Manager in systems with a total of five SMA inverters and a maximum system size of 135 kVA. When used as System Manager, the Sunny Tripower X in conjunction with an energy meter takes over the control at the point of interconnection and can control up to four lower-level inverters. The System Manager also takes over system monitoring and communication to the Sunny Portal powered by ennexOS.

User interface for configuration and monitoring

The product is equipped as standard with an integrated webserver, which provides a user interface for configuring and monitoring the product.

Once a connection has been established to a smart end device (e.g. laptop or tablet PC), the product's user interface can be called up using a web browser.

If the product is used as System Manager, up to four lower-level SMA inverters and one SMA energy meter can be configured and commissioned via the user interface of the product.

SMA Speedwire

The product is equipped with SMA Speedwire as standard. SMA Speedwire is a type of communication based on the Ethernet standard. SMA Speedwire is designed for a data transfer rate of 100 Mbps and enables optimum communication between Speedwire devices within systems.

The products supports the encrypted system communication with SMA Speedwire Encrypted Communication. In order to be able to use the Speedwire encryption in the system, all Speedwire devices, except for the SMA Energy Meter, must support the function SMA Speedwire Encrypted Communication.

Wi-Fi

The product is equipped with a Wi-Fi interface as standard. The inverter is delivered with the WLAN interface activated as standard. If you do not want to use WLAN, you can deactivate the WLAN interface.

In addition, the product has a WPS function. The WPS function is for automatically connecting the product to a network (e.g. via router) and establish a direct connection between the product and a smart end device.

Device Key (DEV KEY)

The device key allows you to reset the administrator account and assign a new password if you forget the administrator password for the product. The device key can be used to prove the identity of the product in digital communication. The Device Key is located on the back of the quick reference guide that comes with the product. Keep the device key safe in case you forget the administrator password.

Digital inputs

The product is equipped with digital inputs as standard.

Digital input **DI 1-4** is intended for connection of a ripple control receiver or remote terminal unit for control by the grid operator.

Digital input **DI 5** is intended for connection of a fast-stop switch (break contact).

Digital input **DI 6** is intended for connection of an external grid and PV system protection device (break contact).

Grid management services

The product is equipped with service functions for grid management.

Depending on the requirements of the grid operator, you can activate and configure the functions (e.g. active power limitation) via operating parameters.

The setpoints from the grid operator can either be implemented via open-loop control or closed-loop control. The setpoints are specified via Modbus, analog or digital signals or manually via the user interface. The implementation of the setpoints is reported back to the grid operator.

Surge arrester type 1 and 2 or type 2

The inverter includes a slot for DC overvoltage protection. The DC overvoltage protection with surge protection devices of the type 1 and 2 or type 2 is available as an accessory. The surge protection devices limit dangerous overvoltages.

SMA ArcFix

SMA ArcFix is an Arc Fault Circuit Interrupter (AFCI). With this function, the inverter effectively detects arcs on the DC side and interrupts them.

A detected electric arc causes the inverter to interrupt feed-in operation. To restart feed-in operation, the operational disruption which has occurred must be reset. Alternatively, the arc-fault circuit interrupter can be activated without inhibiting operation. Depending on the country data set, arc fault detection is activated or deactivated by default. If the installation conditions permit this, you can change the default setting.

SMA ArcFix complies with the requirements of the draft standard IEC 63027 ED1 (82/1636/CDV) and corresponds to the following installation classes within the scope of IEC 63027:

- F-I-AFPE-1-6-1
- F-I-AFPE-2-3-1

Integrated Plant Control

The inverter can display the Q(V) characteristic curve specified by the grid operator by means of Integrated Plant Control without measuring on the grid-connection point. The inverter can automatically compensate equipment installed between the inverter and the grid-connection point after having activated the function (for information on the system configuration refer to the Technical Information "Integrated Plant Control" at www.SMA-Solar.com).

SMA Smart Connected

SMA Smart Connected is the free monitoring of the product via the SMA Sunny Portal. Thanks to SMA Smart Connected, the operator and qualified person will be informed automatically and proactively about product events that occur.

SMA Smart Connected is activated during registration in Sunny Portal. In order to use SMA Smart Connected, it is necessary that the product is permanently connected to Sunny Portal and the data of the operator and qualified person is stored in Sunny Portal and up-to-date.

4.5 Device Configuration

You can configure the Sunny Tripower X either as System Manager or as a lower-level inverter.

When using a Sunny Tripower X as System Manager, you can integrate up to four additional SMA inverters and one SMA energy meter in a system.

Inverter as System Manager

If you configure the inverter as System Manager, the inverter as a higher-level device in conjunction with an energy meter takes over the control at the point of interconnection and can receive control signals. The inverter can control other subordinate devices, takes over the monitoring of the system and the communication to the Sunny Portal powered by ennexOS.

Lower-level inverter

If you configure the inverter as a subordinate device, it does not take over control. The lower-level inverter receives directions from the System Manager and executes them. Before a lower-level inverter can be recorded in a System Manager, you must commission all subordinate devices.

4.6 System Overview

4.6.1 Sunny Tripower X as system manager

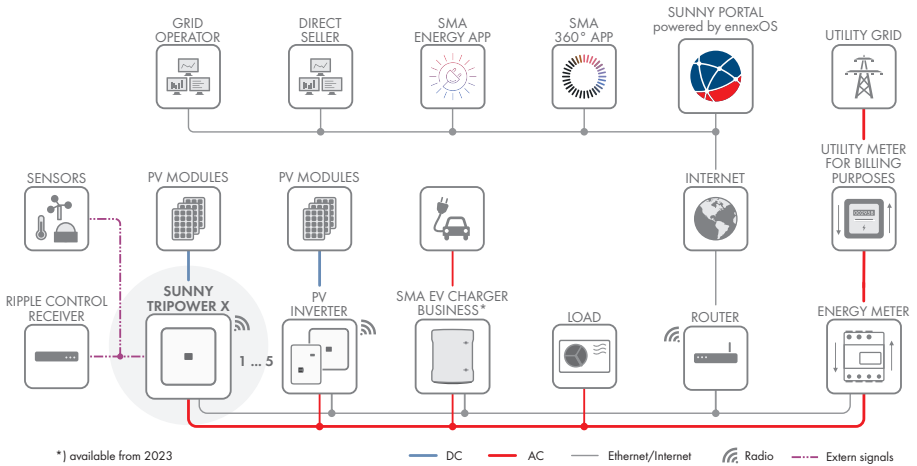

Figure 3: System with Sunny Tripower X as system manager and one energy meter

4.6.2 Sunny Tripower X with Sunny Home Manager 2.0

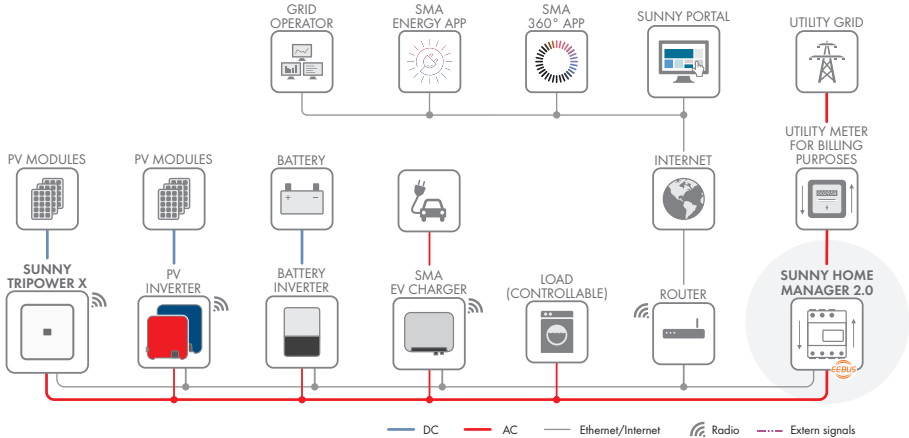

Figure 4: System with Sunny Tripower X and Sunny Home Manager 2.0

4.6.3 Sunny Tripower X with SMA Data Manager

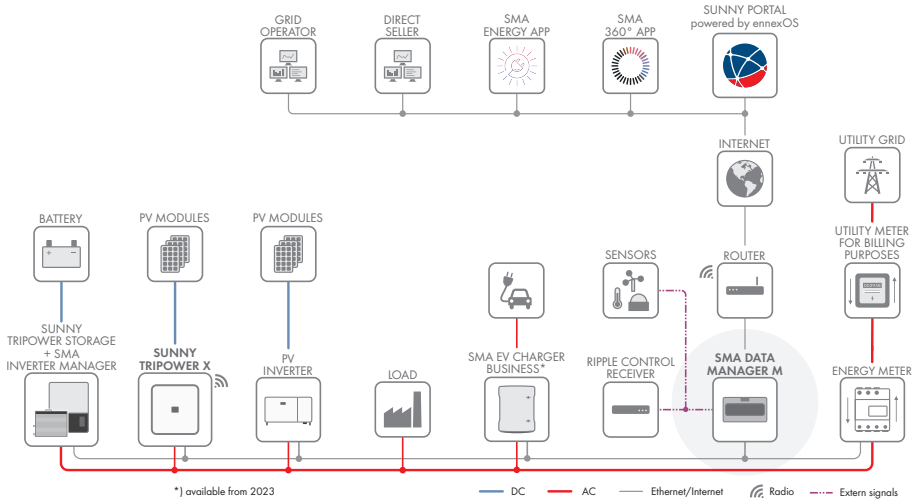

Figure 5: System with Sunny Tripower X and SMA Data Manager as system manager

5 Mounting

5.1 Requirements for Mounting

Requirements for the mounting location:

⚠ WARNING

Danger to life due to fire or explosion

Despite careful construction, electrical devices can cause fires. This can result in death or serious injury.

- Do not mount the product in areas containing highly flammable materials or gases.
 - Do not mount the product in potentially explosive atmospheres.
- Do not mount the inverter on a pillar.
 - A solid support surface must be available (e.g., concrete or masonry). When mounted on drywall or similar materials, the product emits audible vibrations during operation which could be perceived as annoying.
 - The mounting location must be inaccessible to children.
 - The mounting location must be suitable for the weight and dimensions of the product (see Section 13, page 90).
 - The installation site can be exposed to direct solar irradiation. There is, however, the possibility that the product reduces its power output to avoid overheating due to high temperatures.
 - The mounting location should be freely and safely accessible at all times without the need for any auxiliary equipment (such as scaffolding or lifting platforms). Non-fulfilment of these criteria may restrict servicing.
 - The DC load-break switch of the product must always be freely accessible.
 - All ambient conditions must be met (see Section 13, page 90).
 - To ensure optimum operation, the ambient temperature should be between 0°C and +45°C.

Permitted and prohibited mounting positions:

- The product may only be mounted in a permitted position. This will ensure that no moisture can penetrate the product.
- The product should be mounted such that the LED signals can be read off without difficulty.

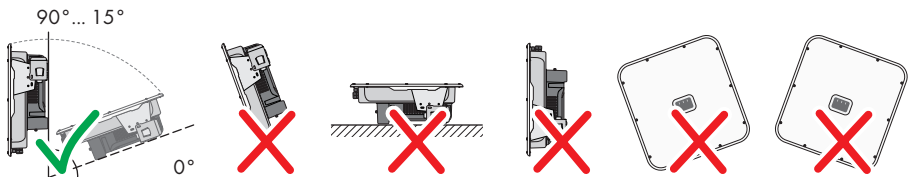

Figure 6: Permitted and prohibited mounting positions

Dimensions for mounting:

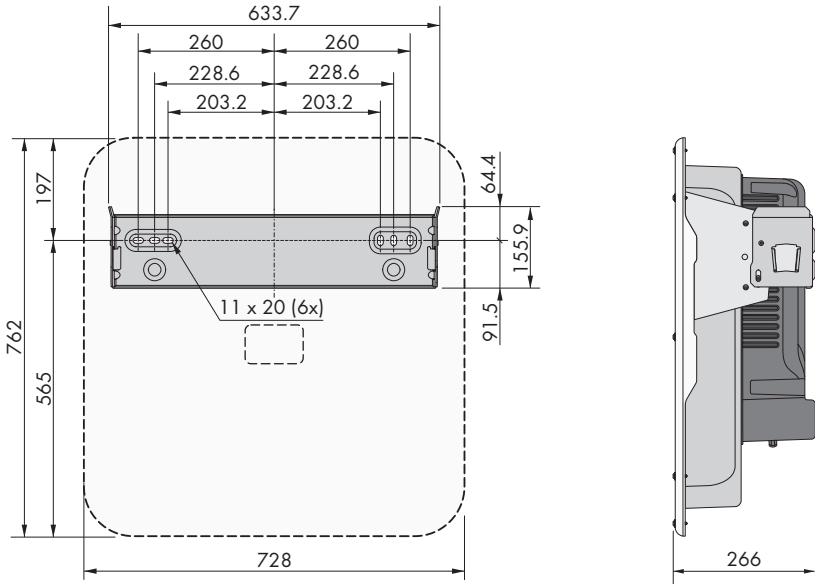

Figure 7: Position of the anchoring points(Dimensions in mm)

Recommended clearances:

If you maintain the recommended clearances, adequate heat dissipation will be ensured. Thus, you will prevent power reduction due to excessive temperature.

- Maintain the recommended clearances to walls as well as to other inverters or objects.
- If multiple products are mounted in areas with high ambient temperatures, increase the clearances between the products and ensure sufficient fresh-air supply.

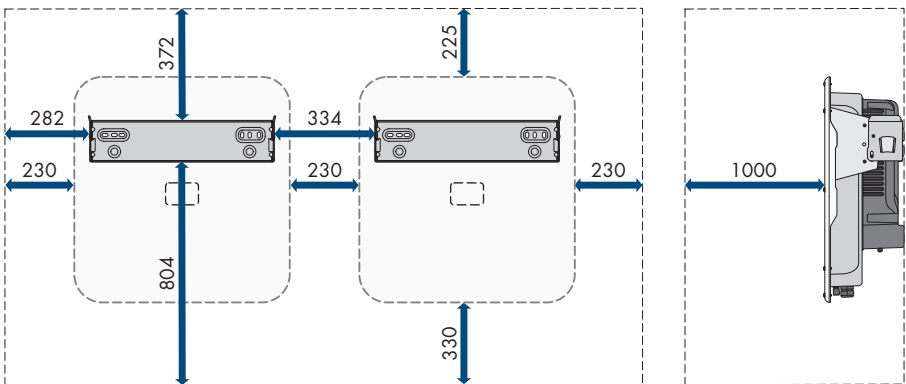

Figure 8: Recommended clearances(Dimensions in mm)

5.2 Mounting the product

Additionally required mounting material (not included in the scope of delivery):

- For transport with a hoist: 2 eye bolts (M8)
- For mounting:
 - Two screws that are suitable for the support surface and the weight of the inverter
 - 2 washers suitable for the screws
 - Where necessary, 2 screw anchors suitable for the support surface and the screws
- To protect the product against theft: 1 padlock suitable for outdoor use. The padlock shackle should have a 7.5 mm diameter.

CAUTION

Risk of injury due to weight of product

Injuries may result if the product is lifted incorrectly or dropped while being transported or mounted.

- Transport and lift the product carefully. Take the weight of the product into account.
- Use the carrying handles or hoist when transporting the product. To attach the hoist system, eye bolts must be screwed into the threads provided, which are located on the right and left of the product's mounting lugs.
- Wear suitable personal protective equipment for all work on the product.

Procedure:

1. Align the wall mounting bracket horizontally on the wall and mark the position of the drill holes.
2. Set the wall mounting bracket aside and drill the marked holes.
3. Insert screw anchors into the drill holes if the support surface requires them.
4. Secure the wall mounting bracket horizontally using screws and washers.

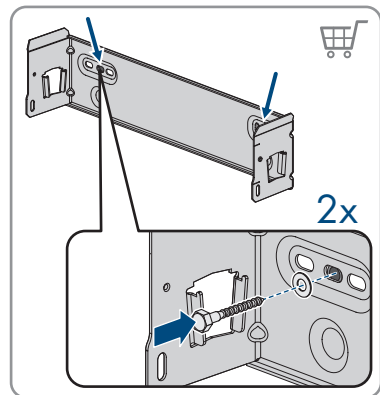

5. Hook the inverter into the wall mounting bracket.

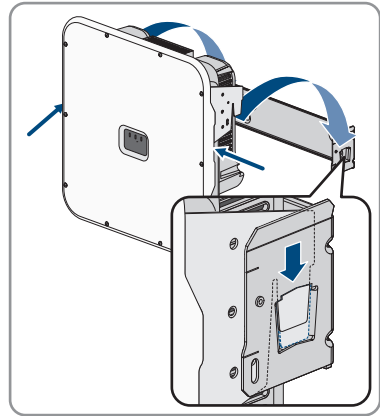

6. Ensure that the inverter is securely in place. The inverter is correctly hooked in when the indentations in the wall mounting bracket and the mounting tab line up.

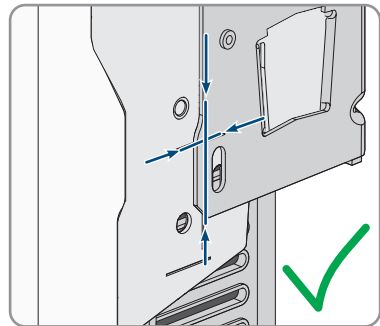

7. Secure the inverter to the wall mounting bracket on both sides with an M5x14 hexagon socket screw. Insert screws into the screw holes on the left and right tab of the wall mounting bracket and tighten them (TX25, torque: 1.5 Nm).

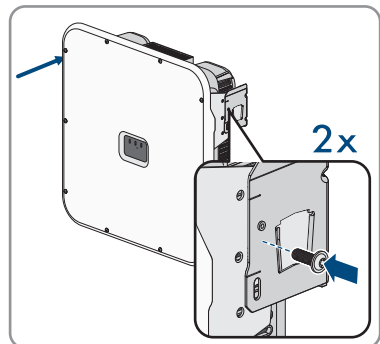

8. To secure the inverter against theft, guide the padlock shackle through the metal tab of the wall mounting bracket and through the mounting tab of the inverter before closing it.

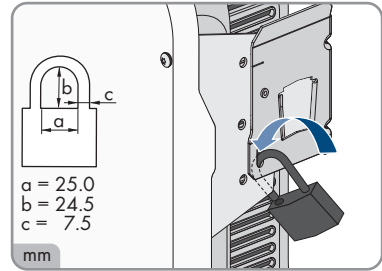

9. Keep the key of the padlock or the code for opening it in a safe place.

6 Electrical Connection

6.1 Overview of the Connection Area

6.1.1 View from Below

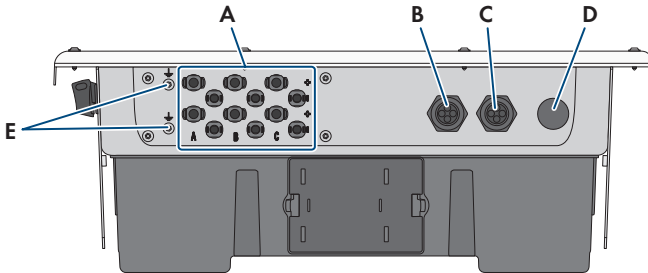

Figure 9: Bottom view of product

Position	Designation
A	Positive and negative connectors for DC connection
B	Enclosure opening for the network cables and, if needed, for other data cables
C	Enclosure opening for connecting to the digital inputs and to the multifunction relay
D	Enclosure opening for connecting the utility grid
E	Connection point for an additional grounding

6.1.2 Interior View

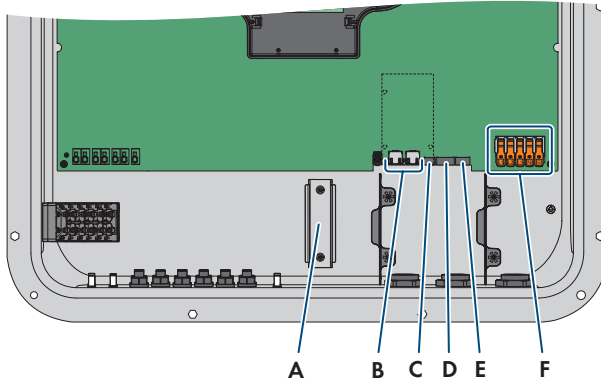

Figure 10: Connection areas in the interior of the product

Position	Designation
A	DIN rail for installing the DC overvoltage protection
B	Network Ports
C	MFR slot for connection to the multifunction relay
D	Slot DI 1-4 for connecting a ripple control receiver
E	Slot DI 5-7 for connecting external signal sources (e.g. fast-stop switch or switch for an external grid and PV system protection device)
F	Terminal blocks for AC connection

6.2 AC Connection

6.2.1 Requirements for the AC Connection

AC cable requirements as follows:

- Conductor type: copper wire
- The conductors must be solid or fine-stranded. When using fine-stranded wire, bootlace ferrules can be used.
- External diameter: 14 mm to 25 mm
- Conductor cross-section PE: 6 mm² to 16 mm²
 The minimum conductor cross-section of 6 mm² is only permitted if additional grounding is connected. If no additional grounding is connected, the minimum conductor cross-section is 10 mm².
- Conductor cross-section of line conductor and neutral conductor: 6 mm² to 16 mm²
- Insulation stripping length: 18 mm to 20 mm

- Sheath stripping length: 120 mm to 150 mm
- The cable must be dimensioned in accordance with the local and national directives for the dimensioning of cables. The requirements for the minimum wire size derive from these directives. Examples of factors influencing cable dimensioning are: nominal AC current, type of cable, routing method, cable bundling, ambient temperature and maximum desired line losses (for calculation of line losses, see the design software "Sunny Design" from software version 2.0 at www.SMA-Solar.com).

Load-break switch and cable protection:

NOTICE

Damage to the inverter due to the use of screw-type fuses as load-break switches

Screw-type fuses (e.g. DIAZED fuse or NEOZED fuse) are not load-break switches.

- Do not use screw-type fuses as load-break switches.
 - Use a load-break switch or circuit breaker as a load disconnection unit (for information and design examples, see the Technical Information "Circuit Breaker" at www.SMA-Solar.com).
- In PV systems with multiple inverters, protect each inverter with a separate three-phase circuit breaker. Make sure to observe the maximum permissible fuse protection (see Section 13, page 90). This will prevent residual voltage from being present at the corresponding cable after disconnection.
 - Loads installed between the inverter and the circuit breaker must be fused separately.

Residual-current monitoring unit:

The inverter does not require an external residual-current device when operating. If local regulations require the use of a residual-current device, the following must be observed:

- The inverter is compatible with type A and B residual-current devices that have a rated residual current of 100 mA or higher (information about the selection of a residual-current device see technical information "Criteria for Selecting a Residual-Current Device" at www.SMA-Solar.com). Each inverter in the system must be connected to the utility grid via a separate residual-current device.

Overvoltage category:

The product can be used in grids of overvoltage category III or lower in accordance with IEC 60664-1. That means that the product can be permanently connected to the grid-connection point of a building. In case of installations with long outdoor cabling routes, additional measures to reduce overvoltage category IV to overvoltage category III are required (see the Technical Information "Overvoltage Protection" at www.SMA-Solar.com).

Additional grounding:**i Safety in accordance with IEC 62109**

The inverter is not equipped with a grounding conductor monitoring device. In order to guarantee safety in accordance with IEC 62109, you must take one of the following measures:

- Connect a grounding conductor made of copper wire with a cross-section of at least 10 mm² to the connecting terminal plate for the AC cable.
- Connect additional grounding with the same cross-section as the connected grounding conductor to the connecting terminal plate for the AC cable (see Section 6.2.3, page 34). This prevents touch current if the grounding conductor at the connecting terminal plate for the AC cable fails.

i Connection of additional grounding

In some countries, additional grounding is generally required. In each case, observe the locally applicable regulations.

- If additional grounding is required, connect an additional grounding that has at least the same cross-section as the connected grounding conductor to the connecting terminal plate for the AC cable (see Section 6.2.3, page 34). This prevents touch current if the grounding conductor at the connecting terminal plate for the AC cable fails.

6.2.2 Connecting the Inverter to the Utility Grid**⚠ QUALIFIED PERSON****Procedure:**

1. Disconnect the miniature circuit breaker from all 3 line conductors and secure against reconnection.
2. Ensure that the DC load-break switch is in the **0** position.

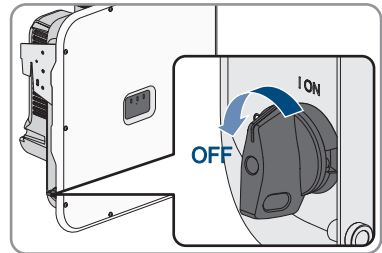

3. If your country requires the DC load-break switch to be protected against reconnection, secure the DC load-break switch against reconnection with a padlock.

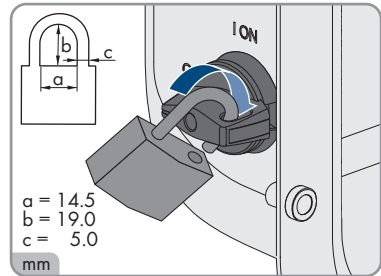

4. Unscrew the screws of the enclosure lid with a Torx screwdriver (TX 25) and remove the enclosure lid carefully forward.

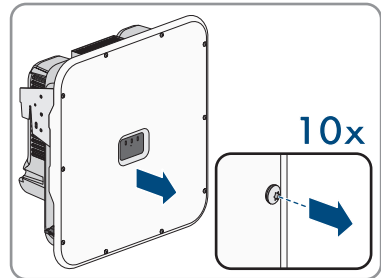

5. Remove the adhesive tape from the enclosure opening for the AC connection.

6. Insert the cable gland M32x1.5 into the opening and tighten it with the counter nut from the inside.

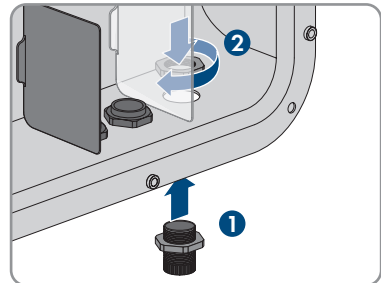

7. Route the AC cable into the inverter through the cable gland. If necessary, slightly loosen the swivel nut of the cable gland.
8. Dismantle the AC cable.
9. Strip off the conductor insulation by 18 mm to 20 mm each.
10. If necessary, provide each conductor with a bootlace ferrule.

11. Press the locking lever of terminal **PE** upward, guide conductor **PE** into the terminal, and press locking lever downward again.

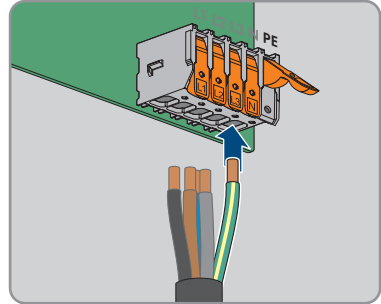

12. For connection without a neutral conductor, use the jumper provided to bridge terminal blocks **PE** and **N**. For this, press the locking levers of terminals **PE** and **N** upward, guide the jumper into the terminals, and press the locking levers downward again.

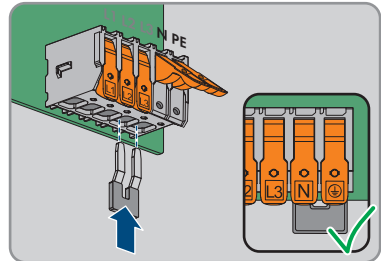

13. Press the locking levers of terminals **L1**, **L2**, **L3**, and if applicable **N** upward, guide conductors **L1**, **L2**, **L3**, and if applicable **N** into the terminals according to the labeling, and press the locking levers downward again.

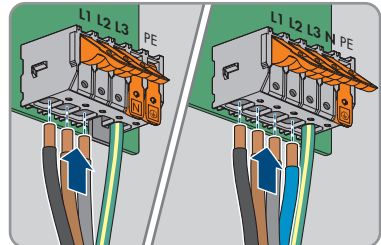

14. Ensure that the correct conductors are assigned to all the terminals.
15. Ensure that all conductors are securely in place.

6.2.3 Connecting Additional Grounding

⚠ QUALIFIED PERSON

If additional grounding or equipotential bonding is required locally, you can connect additional grounding to the product. This prevents touch current if the grounding conductor at the terminal for the AC cable fails.

Additionally required material (not included in the scope of delivery):

- 1 grounding cable
- 1 ring terminal lug M5

Cable requirements:

- Cable cross-section: Corresponds at least to the cross-section of the protective conductor connected to the terminal block for the AC connection

Procedure:

1. Dismantle the grounding cable.
2. Fit a terminal lug to the grounding cable.

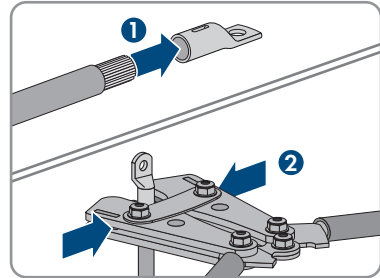

3. Clean the contact surfaces of the terminal lug using a clean cloth and ethanol cleaning agent and do not touch the contact surfaces after cleaning.
4. Connect the grounding cable to a connection point for additional grounding or equipotential bonding using a hexagon socket screw M5x14, a washer, and a serrated conical spring washer (TX25, torque: 4 Nm).

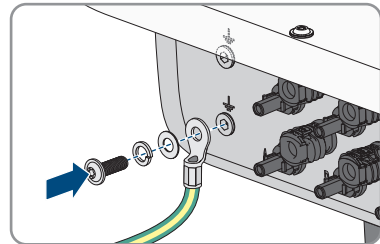

6.3 Connecting the Ripple Control Receiver

⚠ QUALIFIED PERSON

A ripple control receiver or remote terminal unit can be connected to digital input **DI 1-4**.

In a multi-inverter system, the ripple control receiver must be connected to digital input **DI 1-4** of the System Manager.

Additionally required material (not included in the scope of delivery):

- 1 ripple control receiver

Requirements:

- The signal source must be technically suitable for connection to the digital inputs (see Section 13, page 90).

Cable requirements:

The cable length and quality affect the quality of the signal. Observe the following cable requirements:

- Number of wires: at least 5
- Conductor cross-section: 0.5 mm² to 0.75 mm²
- External diameter: Max. 8 mm
- Maximum cable length: 30 m
- UV-resistant for outdoor use

Pin assignment:

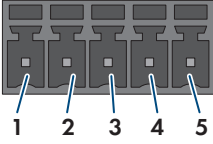
Digital input	Pin	Assignment
	1	Digital input 1
	2	Digital input 2
	3	Digital input 3
	4	Digital input 4
	5	Voltage supply output

Circuitry overview:

Figure 11: Connection of a ripple control receiver to digital input DI 1-4

Procedure:

1. Connect the connection cable to the digital signal source (see the manual from manufacturer).
2. Disconnect the inverter from all voltage sources (see Section 9, page 60).
3. Unscrew the swivel nut from the cable gland.
4. Remove the four-hole cable support sleeve from the cable gland.
5. Remove the plug from one of the enclosure openings and cut into the enclosure opening with a utility knife
6. Insert the cable into the enclosure opening.
7. Press the four-hole cable support sleeve with the cable into the cable gland and guide the cable to slot **DI 1-4**. Ensure that the unused enclosure openings of the four-hole cable support sleeve are sealed with sealing plugs.
8. Dismantle the cable by 150 mm.
9. Strip off the conductor insulation by 6 mm.

10. Release the conductor entries on the supplied five-pole plug.

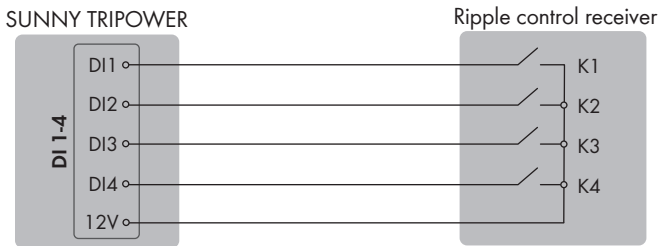
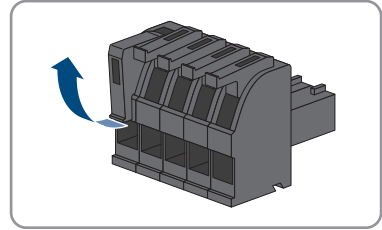

11. Connect the connection cable to the supplied five-pole plug. To do so, plug the conductors into the conductor entries and close the conductor entries. Observe the plug assignment.

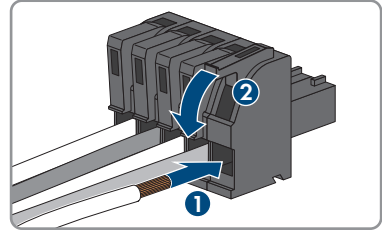

12. Plug the five-pole plug into the port **DI 1-4** on the product. Observe the pin assignment.

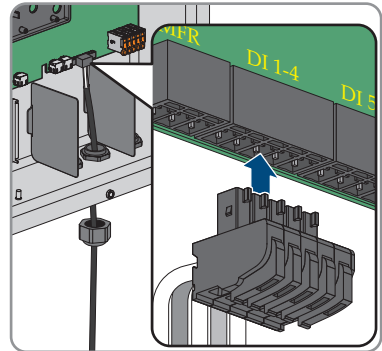

13. Ensure that the plug is securely in place.

14. Ensure that all conductors are correctly connected.

15. Ensure that the conductors sit securely in the terminal points.

16. Tighten the swivel nut on the cable gland hand-tight.

6.4 Connecting the Network Cables

QUALIFIED PERSON

DANGER

Danger to life due to electric shock in case of overvoltages and if surge protection is missing

Overvoltages (e. g. in the event of a flash of lightning) can be further conducted into the building and to other connected devices in the same network via the network cables or other data cables if there is no surge protection. Touching live parts and cables results in death or lethal injuries due to electric shock.

- Ensure that all devices in the same network are integrated in the existing overvoltage protection.
- When laying the network cable outdoors, ensure that there is suitable surge protection at the network cable transition from the product outdoors to the network inside the building.
- The Ethernet interface of the product is classified as "TNV-1" and offers protection against overvoltages of up to 1.5 kV.

Additionally required material (not included in the scope of delivery):

- Network cables
- Where required: Field-assembly RJ45 connector.

Network cable requirements:

The cable length and quality affect the quality of the signal. Observe the following cable requirements:

- Cable type: 100BaseTx
- Cable category: minimum CAT5e
- Plug type: RJ45 of Cat5, Cat5e or higher
- Shielding: SF/UTP, S/UTP, SF/FTP or S/FTP
- Number of insulated conductor pairs and insulated conductor cross-section: at least 2 x 2 x 0.22 mm²
- Maximum cable length between 2 nodes when using patch cables: 50 m
- Maximum cable length between 2 nodes when using installation cables: 100 m
- UV-resistant for outdoor use.

Procedure:

1. Disconnect the inverter from all voltage sources (see Section 9, page 60).
2. Unscrew the swivel nut from the cable gland.
3. Thread a swivel nut over each network cable.
4. Remove the four-hole cable support sleeve from the cable gland.
5. For each network cable, remove one of the plugs from the enclosure openings and cut into each enclosure opening with a utility knife.

6. Insert each network cable into one of the enclosure opening.
7. Press the 4-hole cable support sleeve into the cable gland and guide each network cable to the network port.
8. When using a self-assembly network cable, assemble the RJ45 connectors and connect them to each network cable (see connector documentation).
9. Insert each network cable into one of the network ports.

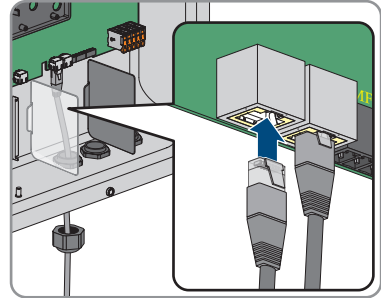

10. Ensure that the network cables are securely in place by pulling slightly on them.
11. Place a ferrite around each network cable.

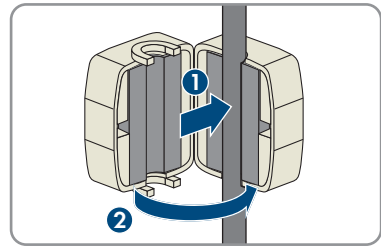

12. Tighten the swivel nut on the cable gland hand-tight. This will secure the network cables in place.
13. If the inverter is installed outdoors, install overvoltage protection for all components in the network.
14. If you would like to integrate the inverter into a local network, connect the other end of a network cable to the local network (e.g. via a router).

6.5 Connection to the Multifunction Relay

⚠ QUALIFIED PERSON

Requirement:

- The technical requirements of the multifunction relay must be met (see Section 13, page 90).

Cable requirements:

- Conductor cross-section: 0.5 mm² to 0.75 mm²
- Maximum cable length: 30 m
- The cable type and cable-laying method must be appropriate for the application and location.

Pin assignment:

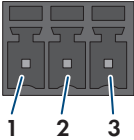
Digital input	Pin	Assignment
	1	NO
	2	CO
	3	NC

Procedure:

1. Disconnect the inverter from all voltage sources (see Section 9, page 60).
2. Unscrew the swivel nut from the cable gland.
3. Remove the four-hole cable support sleeve from the cable gland.
4. Remove the plug from one of the enclosure openings and cut into the enclosure opening with a utility knife
5. Insert the cable into the enclosure opening.
6. Press the four-hole cable support sleeve with the cable into the cable gland and guide the cable to slot **MFR**. Ensure that the unused enclosure openings of the four-hole cable support sleeve are sealed with sealing plugs.

7. Strip 6 mm of the cable insulation at maximum.
8. Connect the cable to the 3-pole terminal block according to the circuit diagram, depending on the operating mode Connection Options. Ensure that the conductors are plugged completely into the terminal points up to their insulation.

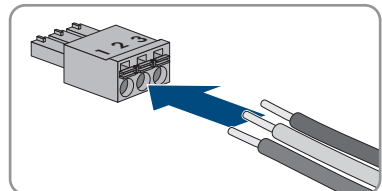

9. Insert the three-pole terminal block with the connected conductors into slot **MFR**.

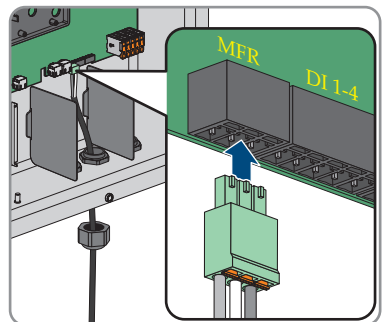

10. Ensure that the terminal block is securely in place.
11. Ensure that all conductors are correctly connected.

12. Ensure that the conductors sit securely in the terminal points. Tip: To release the conductors, open the terminal points using a suitable tool.
13. Tighten the swivel nut on the cable gland hand-tight.

6.6 Connecting Signal Source to Digital Input DI 5-6

⚠ QUALIFIED PERSON

You can connect a fast-stop switch at digital input 5.

You can connect an external grid and PV system protection device at digital input 6.

Additionally required material (not included in the scope of delivery):

- 1 relay for the grid and PV system protection (break contact)
- 1 fast-stop switch (break contact)

Requirements:

- The signal source must be technically suitable for connection to the digital inputs (see Section 13, page 90).

Cable requirements:

The cable length and quality affect the quality of the signal. Observe the following cable requirements:

- Conductor cross-section: 0.5 mm² to 0.75 mm²
- External diameter: Max. 8 mm
- Maximum cable length: 30 m
- UV-resistant for outdoor use

Pin assignment:

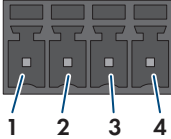
Digital input	Pin	Assignment
	1	Digital input 5
	2	Digital input 6
	3	Not assigned
	4	Voltage supply output

Circuitry overview for digital input 5:

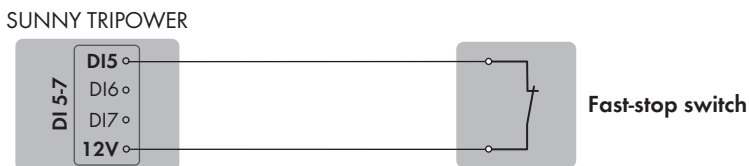

Figure 12: Connection of a fast-stop switch to digital input DI 5

Circuitry overview for digital input 6:

Figure 13: Connection of a relay for the external grid and PV system protection device to digital input DI 6

Procedure:

1. Connect the connection cable to the digital signal source (see the manual from manufacturer).
2. Disconnect the inverter from all voltage sources (see Section 9, page 60).
3. Unscrew the swivel nut from the cable gland.
4. Remove the four-hole cable support sleeve from the cable gland.
5. Remove the plug from one of the enclosure openings and cut into the enclosure opening with a utility knife
6. Insert the cable into the enclosure opening.
7. Press the four-hole cable support sleeve with the cable into the cable gland and guide the cable to slot **DI 5-7**. Ensure that the unused enclosure openings of the four-hole cable support sleeve are sealed with sealing plugs.
8. Dismantle the cable by 150 mm.
9. Strip off the conductor insulation by 6 mm.
10. Release the conductor entries on the supplied four-pole plug.

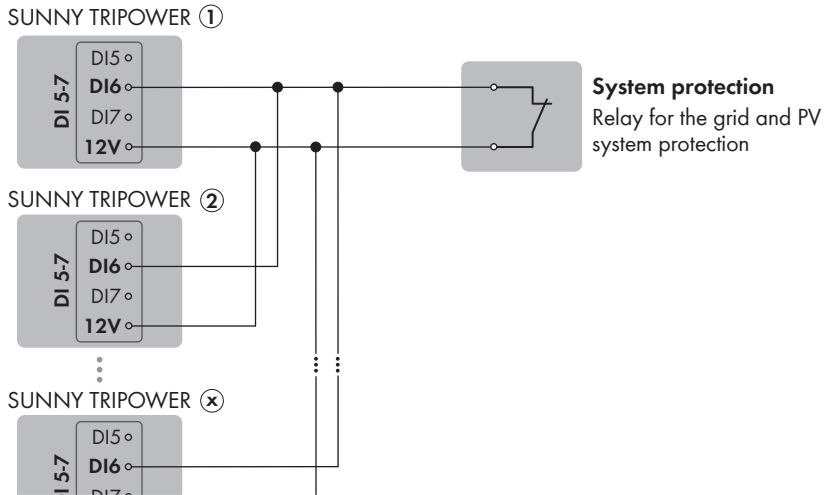
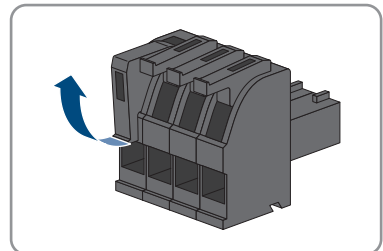

11. Connect the connection cable to the supplied four-pole plug. To do so, plug the conductors into the conductor entries and close the conductor entries. Observe the plug assignment.

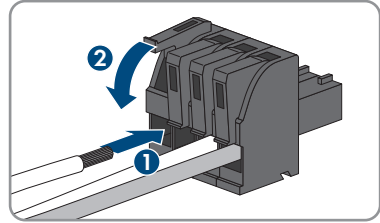

12. Plug the four-pole plug into port **DI 5-7** on the product. Observe the pin assignment.

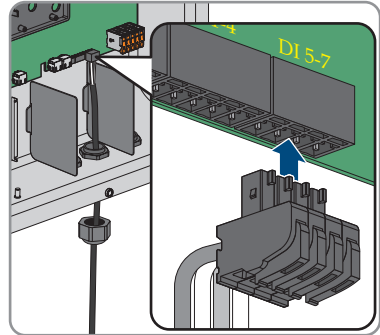

13. Ensure that the plug is securely in place.
 14. Ensure that all conductors are correctly connected.
 15. Ensure that the conductors sit securely in the terminal points.
 16. Tighten the swivel nut on the cable gland hand-tight.

6.7 DC Connection

6.7.1 Requirements for the DC Connection

Requirements for the PV modules per input:

- All PV modules should be of the same type.
- All PV modules should be aligned and tilted identically.
- On the coldest day based on statistical records, the open-circuit voltage of the PV array must never exceed the maximum input voltage of the inverter.
- The same number of series-connected PV modules must be connected to each string.
- The maximum input current per string must be maintained and must not exceed the through-fault current of the DC connectors (see Section 13, page 90).
- The thresholds for the input voltage and the input current of the inverter must be adhered to (see Section 13, page 90).
- The positive connection cables of the PV modules must be equipped with positive DC connectors (see Section 6.7.2, page 44).
- The negative connection cables of the PV modules must be equipped with the negative DC connectors (see Section 6.7.2, page 44).

i Use of Y adapters for parallel connection of strings

The Y adapters must not be used to interrupt the DC circuit.

- Do not use the Y adapters in the immediate vicinity of the inverter. The adapters must not be visible or freely accessible.
- In order to interrupt the DC circuit, always disconnect the inverter as described in this document (see Section 9, page 60).

6.7.2 Assembling the DC Connectors

⚠ QUALIFIED PERSON

⚠ DANGER

Danger to life due to electric shock when live components or DC cables are touched

When exposed to light, the PV modules generate high DC voltage which is present in the DC cables. Touching live DC cables results in death or lethal injuries due to electric shock.

- Do not touch non-insulated parts or cables.
- Disconnect the product from voltage sources and ensure it cannot be reconnected before working on the device.
- Do not disconnect the DC connectors under load.
- Wear suitable personal protective equipment for all work on the product.

NOTICE

Destruction of the inverter due to overvoltage

If the open-circuit voltage of the PV modules exceeds the maximum input voltage of the inverter, the inverter can be destroyed due to overvoltage.

- If the open-circuit voltage of the PV modules exceeds the maximum input voltage of the inverter, do not connect any strings to the inverter and check the design of the PV system.

For connection to the inverter, all PV module connection cables must be fitted with the DC connectors provided. Assemble the DC connectors as described in the following. The procedure is identical for both connectors (+ and -). The graphics for the procedure are shown for only the positive connector as an example. Pay attention to the correct polarity when assembling the DC connectors. The DC connectors are marked with the symbols "+" and "-".

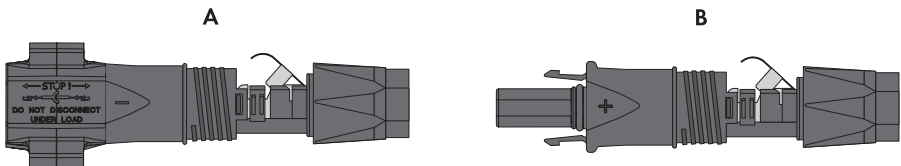

Figure 14: Negative (A) and positive (B) DC connectors

Cable requirements:

- External diameter: 5.5 mm to 8 mm

- Conductor cross-section: 2.5 mm² to 6 mm²
- Qty single wires: minimum 7
- Nominal voltage: minimum 1000 V
- Using bootlace ferrules is not allowed.

Procedure:

1. Strip approx. 15 mm of the cable insulation.
2. Insert the stripped cable into the DC connector up to the stop. When doing so, ensure that the stripped cable and the DC connector are of the same polarity.

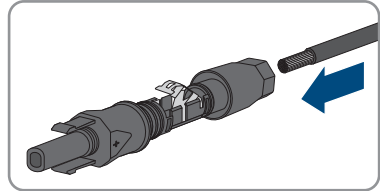

3. Press the clamping bracket down until it audibly snaps into place.

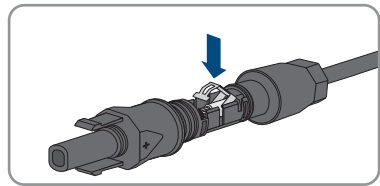

- The stranded wire can be seen inside the clamping bracket chamber.

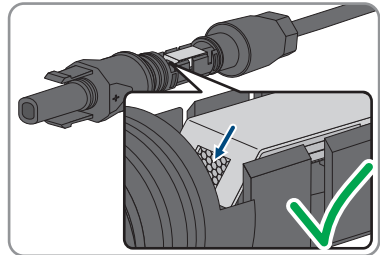

4. If the stranded wire is not visible in the chamber, the cable is not correctly inserted and the connector must be reassembled. To do this, the cable must be removed from the connector.
5. To take out the cable, loosen the clamping bracket. To do so, insert a screwdriver (blade width: 3.5 mm) into the clamping bracket and pry the clamping bracket open.

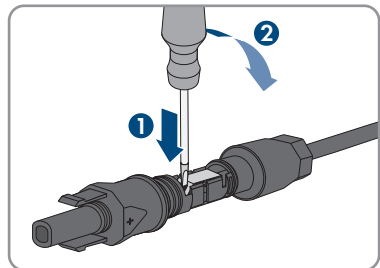

6. Remove the cable and go back to step 2.

7. Push the swivel nut up to the thread and tighten (torque: 2 Nm).

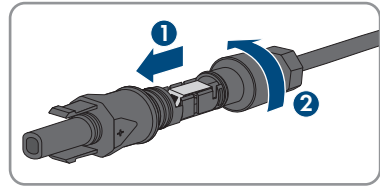

6.7.3 Connecting the PV Array

⚠ QUALIFIED PERSON

⚠ WARNING

Danger to life due to electric shock from destruction of the measuring device due to overvoltage

Overvoltage can damage a measuring device and result in voltage being present in the enclosure of the measuring device. Touching the live enclosure of the measuring device results in death or lethal injuries due to electric shock.

- Only use measuring devices with a DC input voltage range of 1000 V or higher.

NOTICE

Damage to the product due to ground fault on DC side during operation

Due to the transformerless topology of the product, the occurrence of ground faults on DC side during operation can lead to irreparable damage. Damages to the product due to a faulty or damaged DC installation are not covered by warranty. The product is equipped with a protective device that checks whether a ground fault is present during the starting sequence. The product is not protected during operation.

- Ensure that the DC installation is carried out correctly and no ground fault occurs during operation.

NOTICE

Damage to the DC connectors due to the use of contact cleaner of other cleaning agents

Some contact cleaners or other cleaning agents may contain substances that decompose the plastic of the DC connectors.

- Do not use contact cleaners or other cleaning agents for cleaning the DC connectors.

NOTICE

Destruction of the inverter due to overvoltage

If the open-circuit voltage of the PV modules exceeds the maximum input voltage of the inverter, the inverter can be destroyed due to overvoltage.

- If the open-circuit voltage of the PV modules exceeds the maximum input voltage of the inverter, do not connect any strings to the inverter and check the design of the PV system.

Requirements:

- The miniature circuit breaker is switched off and cannot be reconnected.
- The DC load-break switch is set to **OFF** and is protected against reconnection with a padlock according to local regulations.
- The cables of the PV modules must be equipped with DC connectors.

Procedure:

1. Position the enclosure lid and first insert the upper-left (position **1**) and lower-right screws (position **2**) and fasten them hand-tight (TX25).

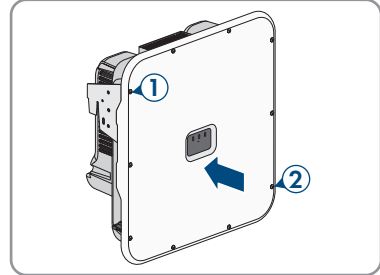

2. Insert and tighten all screws (TX25, torque: $6 \text{ Nm} \pm 0.3 \text{ Nm}$).

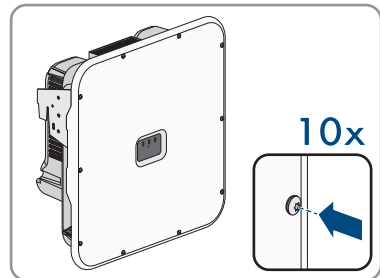

3. Measuring the voltage of the PV array. Ensure that the maximum input voltage of the inverter is adhered to and that there is no ground fault in the PV system.
4. Check whether the DC connectors have the correct polarity.
5. If the DC connector is equipped with a DC cable of the wrong polarity, the DC connector must be reassembled. When this is done, the DC cable must always have the same polarity as the DC connector.
6. Ensure that the open-circuit voltage of the PV array does not exceed the maximum input voltage.

- 7. Connect the assembled DC connectors to the inverter.

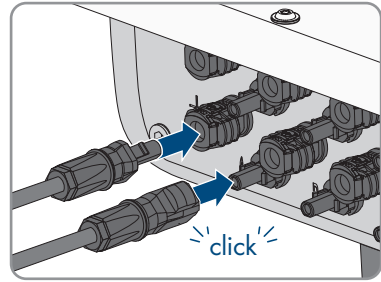

The DC connectors snap into place.

- 8. Ensure that all DC connectors are securely in place.

9.

NOTICE

Damage to the product due to sand, dust and moisture ingress if the DC inputs are not closed

The product is only properly sealed when all unused DC inputs are closed with DC connectors and sealing plugs. Sand, dust and moisture penetration can damage the product and impair its functionality.

- Seal all unused DC inputs using the DC connectors and sealing plugs as described in the following. When doing so, do not plug the sealing plugs directly into the DC inputs on the inverter.

- 10. For unused DC connectors, push down the clamping bracket and push the swivel nut up to the thread.

- 11. Insert the sealing plug into the DC plug connector.

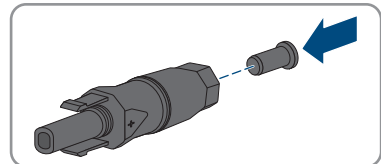

- 12. Insert the DC connectors with sealing plugs into the corresponding DC inputs on the inverter.

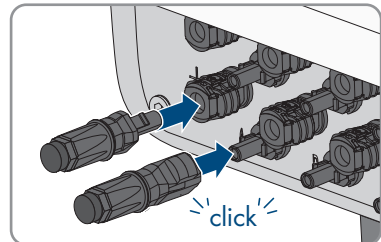

The DC connectors snap into place.

- 13. Ensure that the DC connectors with sealing plugs are securely in place.

6.7.4 Disassembling the DC Connectors

⚠ QUALIFIED PERSON

To disassemble the DC connectors for connection to the pv modules (e.g. due to faulty assembly), proceed as follows.

⚠ DANGER

Danger to life due to electric shock when touching exposed DC conductors or DC plug contacts if the DC connectors are damaged or loose

The DC connectors can break or become damaged, become free of the DC cables, or no longer be connected correctly if the DC connectors are released and disconnected incorrectly. This can result in the DC conductors or DC plug contacts being exposed. Touching live DC conductors or DC plug connectors will result in death or serious injury due to electric shock.

- Wear insulated gloves and use insulated tools when working on the DC connectors.
- Ensure that the DC connectors are in perfect condition and that none of the DC conductors or DC plug contacts are exposed.
- Carefully release and remove the DC connectors as described in the following.

Procedure:

1. Release and remove the DC connectors. To do so, insert a flat-blade screwdriver or an angled screwdriver (blade width: 3.5 mm) into one of the side slots and pull the DC connectors out. When doing so, do not lever the DC connectors out, but insert the tool into one of the side slots only to release the locking mechanism, and do not pull on the cable.

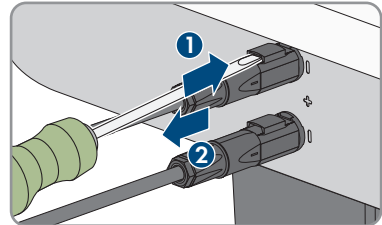

2. Remove the DC connector swivel nut.

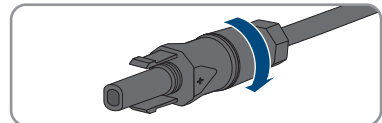

3. Unlock the DC connector. To do this, insert a flat-blade screwdriver (blade width: 3.5 mm) into the side catch mechanism and pry the catch mechanism open.

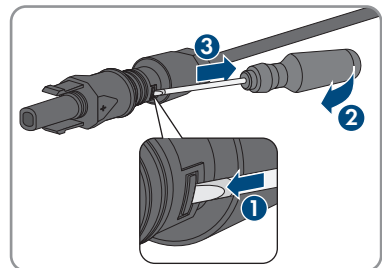

4. Carefully pull the DC connector apart.

5. Release the clamping bracket. To do so, insert a flat-blade screwdriver (blade width: 3.5 mm) into the clamping bracket and pry the clamping bracket open.

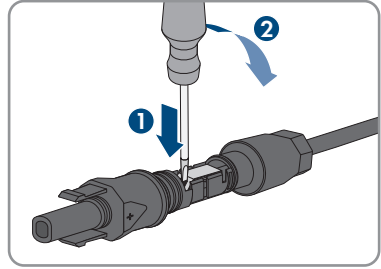

6. Remove the cable.

7 Commissioning

7.1 Commissioning Procedure

QUALIFIED PERSON

This section describes the commissioning procedure and gives an overview of the steps you must perform in the prescribed order.

Procedure	See
1. Commission the product.	Section 7.2, page 51
2. Establish a connection to the user interface of the product. There are various connection options to choose from for this: <ul style="list-style-type: none"> • Direct connection via WLAN • Connection via WLAN in the local network • Connection via Ethernet in the local network 	Section 8.1, page 54
3. Change the network configuration, if necessary. The automatic network configuration recommended by SMA Solar Technology AG via DHCP server is activated by default.	Section 7.3, page 52
4. Carry out the configuration using the installation assistant. Make the following settings: <ul style="list-style-type: none"> • Administrator registration • Device configuration (device name, device function) • Product settings • Add devices (energy meter, Sunny Home Manager 2.0) • Country data set • Meter at the grid feed-in point • External communication • Type of control 	Section 7.4, page 52
5. To monitor the PV system and visualize the PV system data, register in the Sunny Portal and create the system in Sunny Portal or add devices to an existing system.	https://ennexOS.SunnyPortal.com

7.2 Commissioning the Product

QUALIFIED PERSON

Requirements:

- The AC circuit breaker must be correctly rated and mounted.
- The product must be correctly mounted.
- All cables must be correctly connected.

Procedure:

1. If the DC load-break switch has been protected with a padlock, open and remove the padlock on the DC load-break switch.
2. Switch on the DC load-break switch.

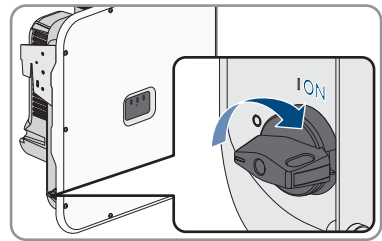

3. Switch on the AC circuit breaker.
4. If the green and red LEDs flash simultaneously during initial commissioning, operation is stopped because no country data set has been set yet. For the inverter to begin operation, the configuration must be completed and a country data set must be set.
5. If the green LED is still flashing, the conditions for activating feed-in operation are not yet met. As soon as the conditions for feed-in operation are met, the inverter starts with feed-in operation and, depending on the available power, the green LED will light up continuously or it will pulse.
6. If the red LED lights up, an event has occurred. Find out which event has occurred and, if necessary, initiate countermeasures (see operating manual of the inverter).
7. Ensure that the inverter feeds in correctly.

7.3 Changing the Network Configuration

⚠ QUALIFIED PERSON

After you connect to the user interface for the first time (see Section 8.1, page 54), the welcome page opens.

On the welcome page, you can change the network configuration. The automatic network configuration recommended by SMA Solar Technology AG via DHCP server is activated by default. Only change the network configurations if the default configuration is not suitable for your network.

Procedure:

1. Select **Change network configuration** on the welcome page.
2. Carry out network configuration and confirm with [**Save**].

7.4 Configuring the Product

⚠ QUALIFIED PERSON

After you connect to the user interface for the first time, the welcome page opens.

If you click on [**Next**], the commissioning assistant starts. With the commissioning assistant, you can create an administrator account to access and configure the product.

Procedure:

1. Click on **[Next]** on the welcome page.
2. Enter the administrator account data and click on **[Next]**. Observe that only 1 user with administrator authorization can be created.
 - The administrator account has been created.
3. Follow the steps of the commissioning assistant and configure your system accordingly. For every setting made in a step, click on **[Next]**.
 - When all steps are completed, the information page is displayed.
4. To open the user interface home page and view product data, click on **[Next]**.

8 Operation

8.1 Establishing a connection to the user interface

8.1.1 Establishing a direct connection via WLAN

You have several options to connect the product to a smart device. The procedure can be different depending on the devices. If the procedures described do not apply to your device, establish the direct connection via Wi-Fi as described in the manual of your device.

The following connection options are available:

- Connection with WPS
- Connection with Wi-Fi network search

i SSID, IP address and WLAN password

- SSID in WLAN: **SMA[serial number]** (e.g. SMA0123456789)
- Device-specific Wi-Fi password: see WPA2-PSK on the type label of the product
- Standard access address for a direct connection via WLAN outside of a local network: **http://smalogin.net** or **192.168.12.3**

Connection with WPS

Requirement:

- The smart device must have a WPS function.

Procedure:

1. Enable the WPS function on the inverter. To do this, tap on the enclosure lid of the inverter twice.
 - The blue LED flashes quickly for approx. two minutes. The WPS function is active during this time.
2. Enable the WPS function on your smart device.
3. Open the web browser of your smart end device and enter **http://smalogin.net** in the address bar.

Connection with Wi-Fi network search

1. Search for Wi-Fi networks with your smart device.
2. Select the SSID of the product **SMA[serial number]** in the list with the detected Wi-Fi networks.
3. Enter the device-specific Wi-Fi password (see WPA2-PSK on the type label).
4. Open the web browser of your smart end device and enter **http://smalogin.net** in the address bar.
 - The welcome or login page of the user interface is displayed.
5. If the login page of the user interface does not open, enter the IP address **192.168.12.3** or, if your smart device supports mDNS services, **SMA[serial number].local** or **http://SMA[serial number]** in the address bar of the web browser.

8.1.2 Establishing a Connection via Ethernet in the local network

i New IP address for connecting with a local network

If the product is connected to a local network (e.g. via a router), the product will receive a new IP address. Depending on the type of configuration, the new IP address will be assigned automatically by the DHCP server (router) or manually by you. Upon completion of the configuration, the product can only be reached via the following access addresses:

- Generally applicable access address: IP address manually assigned or assigned by the DHCP server (router) (identification via network scanner software or network configuration of the router).
- Access address for Apple and Linux systems: **SMA[serial number].local** (e.g. SMA0123456789.local)
- Access address for Windows and Android systems: **https://SMA[serial number]** (e.g. https://SMA0123456789)

i Ports for data communication

In small local networks the use of certain ports is unrestricted. In industrial networks, the use of these ports may require authorization from the system administrator. For proper operation, the outgoing Internet connection must allow the use of the following ports and URLs:

- **Updates:** Port 80 and 443 (http/https) / update.sunnyportal.de
- **Time synchronization with Sunny Portal (if not provided by the Internet router):** Port 123 (NTP) / ntp.sunny-portal.com
- **Data transmission:** Port 443 (https/TLS) / ldm-devapi.sunnyportal.com
- **User interface:** Port 443 (https/TLS) / ennexos.sunnyportal.com
- **SMA Webconnect 1.5 and SMA SPOT:** Port 9524 (TCP) / wco.sunnyportal.com

Requirements:

- The product must be connected to the local network via a network cable (e.g. via a router).
- The product must be integrated into the local network. Tip: There are various methods of integrating the product into the local network with the aid of the installation assistant.
- A smart device (e.g. smartphone, tablet or laptop) must be available.
- The smart device must be in the same local network as the product.
- The respective latest version of one of the following web browsers must be installed on the smart device: Chrome, Edge, Firefox or Safari.

Procedure:

1. Open the web browser of your smart device. Enter the IP address of the product in the address bar of the web browser.

2. Web browser signals a security vulnerability

After the IP address has been entered, a message might appear indicating that the connection to the user interface of the product is not secure. SMA Solar Technology AG guarantees the security of the user interface.

- Continue loading the user interface.

The login page of the user interface opens.

8.1.3 Establishing a Connection via WLAN in the Local Network

New IP address for connecting with a local network

If the product is connected to a local network (e.g. via a router), the product will receive a new IP address. Depending on the type of configuration, the new IP address will be assigned automatically by the DHCP server (router) or manually by you. Upon completion of the configuration, the product can only be reached via the following access addresses:

- Generally applicable access address: IP address manually assigned or assigned by the DHCP server (router) (identification via network scanner software or network configuration of the router).
- Access address for Apple and Linux systems: **SMA[serial number].local** (e.g. SMA0123456789.local)
- Access address for Windows and Android systems: **https://SMA[serial number]** (e.g. https://SMA0123456789)

Requirements:

- The product must be commissioned.
- The product must be integrated into the local network. Tip: There are various methods of integrating the product into the local network with the aid of the installation assistant.
- A smart device (e.g. smartphone, tablet or laptop) must be available.
- The smart device must be in the same local network as the product.
- The respective latest version of one of the following web browsers must be installed on the smart device: Chrome, Edge, Firefox or Safari.

Procedure:

- Enter the IP address of the product in the address bar of the web browser.
 - The login page of the user interface opens.

8.2 Activate WPS Function

The WPS function can be used for different purposes:

- Automatic connection to a network (e.g. via router)
- Direct connection between the product and a smart device

Depending on the intended application of the WPS function, the procedure for activation will vary.

Activating WPS function for automatic connection to a network

Requirements:

- WLAN must be activated in the product.
- WPS must be activated on the router.

Procedure:

1. Open the user interface (see Section 8.1, page 54).
 2. Log into the user interface.
 3. Select the menu item **Network configuration** in the menu **Configuration**.
 4. Click on the button **Use WPS** in the **Wi-Fi** section.
 5. Click on **Save**.
- The WPS function is activated and the automatic connection to the network can be established.

Activating the WPS function for direct connection to the smart device.

- Tap on the enclosure lid of the product twice. This will activate the WPS function on the product for about 2 minutes. Activation is signaled by rapid flashing of the blue LED.

8.3 Speedwire Encryption of the System Communication

Speedwire encryption is used to encrypt system communication between all compatible Speedwire devices. In order to be able to use the Speedwire encryption in the system, all connected Speedwire devices, apart from the SMA Energy Meter, must support the SMA Speedwire Encrypted Communication function.

Requirements:

- All devices in the local network must be in operation and connected to the product via an Internet router.
- All devices must support the Speedwire encryption.

Procedure:

1. Log into the user interface.
2. Select the menu item **Device administration** in the menu **Configuration**.
3. Select the button.
4. Select **SMA Speedwire devices** and confirm with [**Next**].
 - All SMA Speedwire devices in the systems are searched for and displayed.
5. Enable SMA Speedwire encryption and select [**Continue**].
6. Assign a new system password and select [**Save**].

8.4 Activating or Deactivating SMA ArcFix

⚠ QUALIFIED PERSON

Deactivating SMA ArcFix

Procedure:

- Select the parameter **AFCI switched on** or **Parameter.Inverter.AfcilsOn** and set to **No**.

Activating SMA ArcFix with Operation Inhibition

When the arc-fault circuit interrupter is active and an electric arc is detected, the inverter interrupts the feed-in operation and an operation inhibition occurs. The operation inhibition must be reset manually if the inverter is to feed into the grid again (see Section 11.3, page 88).

Procedure:

- Select the parameter **AFCI switched on** or **Parameter.Inverter.AfcilsOn** and set to **Yes**.
- Set the parameter **Manual restart after arc fault detection** or **Parameter.Operation.ManRstr.ManRstrAFCI** to **On**.

Activating SMA ArcFix without Operation Inhibition

When the arc-fault circuit interrupter without operation inhibition is active and an electric arc is detected, the inverter interrupts the feed-in operation. No operation inhibition occurs. After a waiting period, the inverter starts automatically and checks whether the electric arc is still present. If the electric arc is still present, the inverter disconnects from the grid again and the process is repeated.

- Select the parameter **AFCI switched on** or **Parameter.Inverter.AfcilsOn** and set to **Yes**.
- Set the parameter **Manual restart after arc fault detection** or **Parameter.Operation.ManRstr.ManRstrAFCI** to **Off**.

8.5 Creating a Backup File

As soon as the product and all devices are in operation and your system is optimally configured, SMA Solar Technology AG recommends creating a backup file. If you replace your product or reset your existing product to the default settings, the backup file can be used to transfer configuration information. The backup file includes the following system and device configuration data for your product:

- Grid management services
- FTP
- Network
- Sensors
- Analog and digital inputs
- Analog and digital outputs
- Energy meter
- Sunny Portal setting
- Self-defined Modbus profiles

- System password
- User interface login data
- List of connected devices

Note that the following information is not included in the backup file:

- Notifications
- Historic energy and performance values
- Configuration of individual inverters

Procedure:

1. Log into the user interface of the product.
2. Select the product.
3. Select the menu item **Update and backup** in the menu **Configuration**.
4. Select the [**Create backup**] button.
5. Enter a password for encrypting the backup file and confirm with [**Create and download backup**]. Please note that the password will be needed later for importing the backup file.
 - An lbd file with all parameter settings will be downloaded.

8.6 Deleting the Admin Account

In case the password gets lost, the admin account can be reset and newly created. All system data will be retained.

Requirements:

- The device key from the label on the back of the supplied manual must be present.

Procedure:

1. Open the user interface of the product.
 2. Select the [**Delete admin account?**] button.
 3. Enter the device key from the label on the back of the supplied manual.
 4. Select [**Delete**].
- The product is performing a restart. Then a new admin account can be created.

9 Disconnecting the Inverter from Voltage Sources

⚠ QUALIFIED PERSON

Prior to performing any work on the product, always disconnect it from all voltage sources as described in this section. Always adhere to the prescribed sequence.

⚠ WARNING

Danger to life due to electric shock from destruction of the measuring device due to overvoltage

Overvoltage can damage a measuring device and result in voltage being present in the enclosure of the measuring device. Touching the live enclosure of the measuring device results in death or lethal injuries due to electric shock.

- Only use measuring devices with a DC input voltage range of 1000 V or higher.

Procedure:

1. Disconnect the AC miniature circuit breaker and secure against reconnection.
2. Turn the DC load-break switch of the inverter to position **O**.

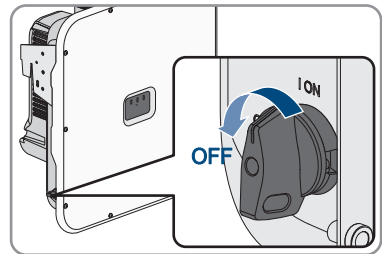

3. If your country requires the DC load-break switch to be protected against reconnection, secure the DC load-break switch against reconnection with a suitable padlock.

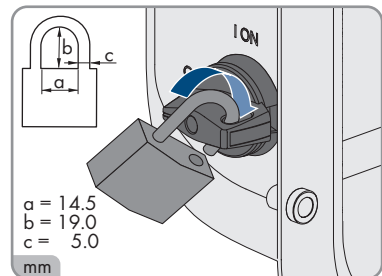

4. If the multifunction relay is used, switch off any supply voltage to the load.
5. Wait until the LEDs have gone out.

6. Use a current clamp to ensure that no current is present in the DC cables.

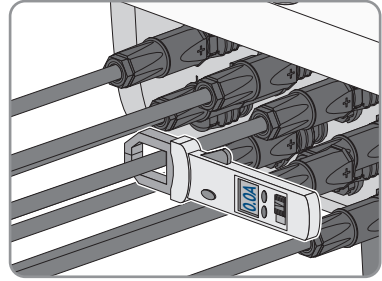

7. Note the position of the DC connector.

8.

⚠ DANGER

Danger to life due to electric shock when touching exposed DC conductors or DC plug contacts if the DC connectors are damaged or loose

The DC connectors can break or become damaged, become free of the DC cables, or no longer be connected correctly if the DC connectors are released and disconnected incorrectly. This can result in the DC conductors or DC plug contacts being exposed. Touching live DC conductors or DC plug connectors will result in death or serious injury due to electric shock.

- Wear insulated gloves and use insulated tools when working on the DC connectors.
- Ensure that the DC connectors are in perfect condition and that none of the DC conductors or DC plug contacts are exposed.
- Carefully release and remove the DC connectors as described in the following.

9. Release and remove the DC connectors. To do so, insert a flat-blade screwdriver or an angled screwdriver (blade width: 3.5 mm) into one of the side slots and pull the DC connectors out. When doing so, do not lever the DC connectors out, but insert the tool into one of the side slots only to release the locking mechanism, and do not pull on the cable.

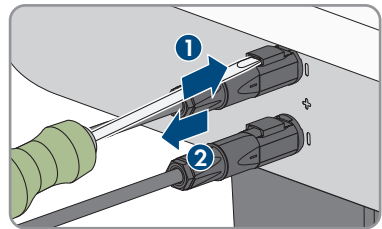

10. Ensure that no voltage is present at the DC inputs on the inverter using a suitable measuring device.

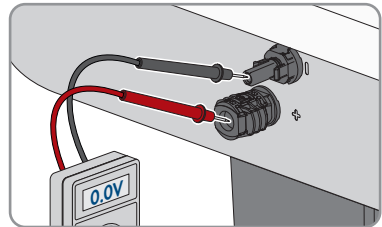

11. Loosen all ten screws of the enclosure lid (TX25) and remove the enclosure lid towards the front.

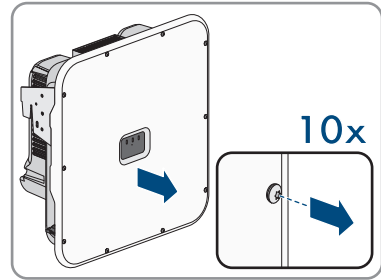

12. Set the screws and the enclosure lid aside and store safely.
13. Check that there is no voltage between L1 and N, L2 and N, and L3 and N at the terminal block for connecting the utility grid. Use a suitable measuring device for this purpose. To do this, insert the test probes through the openings on the terminal block.

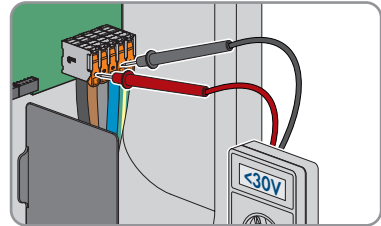

14. Check that there is no voltage between L1 and PE, L2 and PE, and L3 and PE at the terminal block for connecting the utility grid. Use a suitable measuring device for this purpose.

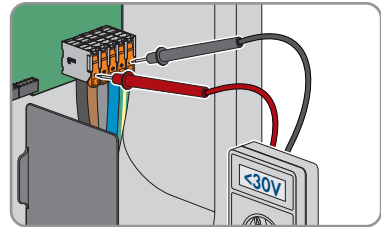

10 Clean the product

NOTICE

Damage to the product due to cleaning agents

The use of cleaning agents may cause damage to the product and its components.

- Clean the product and all its components only with a cloth moistened with clear water.

Procedure:

- Ensure that the product is free of dust, foliage and other dirt.

11 Troubleshooting

11.1 Event Messages

11.1.1 Event 101

QUALIFIED PERSON

Event message:

- System incident

Explanation:

The grid voltage or grid impedance at the connection point of the inverter is too high. The inverter has disconnected from the utility grid.

Corrective measures:

- Check whether the grid voltage at the connection point of the inverter is permanently in the permissible range.

If the grid voltage is outside the permissible range due to local grid conditions, contact the grid operator. The grid operator must agree with an adjustment of the voltage at the feed-in point or with a change of the monitored operating limits.

If the grid voltage is permanently within the permissible range and this message is still displayed, contact the Service.

11.1.2 Event 102

QUALIFIED PERSON

Event message:

- System incident

Explanation:

The grid voltage or grid impedance at the connection point of the inverter is too high. The inverter has disconnected from the utility grid.

Corrective measures:

- Check whether the grid voltage at the connection point of the inverter is permanently in the permissible range.

If the grid voltage is outside the permissible range due to local grid conditions, contact the grid operator. The grid operator must agree with an adjustment of the voltage at the feed-in point or with a change of the monitored operating limits.

If the grid voltage is permanently within the permissible range and this message is still displayed, contact the Service.

11.1.3 Event 103

QUALIFIED PERSON

Event message:

- System incident

Explanation:

The grid voltage or grid impedance at the connection point of the inverter is too high. The inverter has disconnected from the utility grid.

Corrective measures:

- Check whether the grid voltage at the connection point of the inverter is permanently in the permissible range.
If the grid voltage is outside the permissible range due to local grid conditions, contact the grid operator. The grid operator must agree with an adjustment of the voltage at the feed-in point or with a change of the monitored operating limits.
If the grid voltage is permanently within the permissible range and this message is still displayed, contact the Service.

11.1.4 Event 105

QUALIFIED PERSON

Event message:

- System incident

Explanation:

The grid voltage or grid impedance at the connection point of the inverter is too high. The inverter has disconnected from the utility grid.

Corrective measures:

- Check whether the grid voltage at the connection point of the inverter is permanently in the permissible range.
If the grid voltage is outside the permissible range due to local grid conditions, contact the grid operator. The grid operator must agree with an adjustment of the voltage at the feed-in point or with a change of the monitored operating limits.
If the grid voltage is permanently within the permissible range and this message is still displayed, contact the Service.

11.1.5 Event 202

QUALIFIED PERSON

Event message:

- System incident

Explanation:

The utility grid has been disconnected, the AC cable is damaged or the grid voltage at the connection point of the inverter is too low. The inverter has disconnected from the utility grid.

Corrective measures:

- Ensure that the miniature circuit breaker is switched on.
- Ensure that the AC cable is not damaged and that it is connected correctly.
- Ensure that the country data set has been configured correctly.
- Check whether the grid voltage at the connection point of the inverter is permanently in the permissible range.

If the grid voltage is outside the permissible range due to local grid conditions, contact the grid operator. The grid operator must agree with an adjustment of the voltage at the feed-in point or with a change of the monitored operating limits.

If the grid voltage is permanently within the permissible range and this message is still displayed, contact the Service.

11.1.6 Event 203**⚠ QUALIFIED PERSON****Event message:**

- System incident

Explanation:

The utility grid has been disconnected, the AC cable is damaged or the grid voltage at the connection point of the inverter is too low. The inverter has disconnected from the utility grid.

Corrective measures:

- Ensure that the miniature circuit breaker is switched on.
- Ensure that the AC cable is not damaged and that it is connected correctly.
- Ensure that the country data set has been configured correctly.
- Check whether the grid voltage at the connection point of the inverter is permanently in the permissible range.

If the grid voltage is outside the permissible range due to local grid conditions, contact the grid operator. The grid operator must agree with an adjustment of the voltage at the feed-in point or with a change of the monitored operating limits.

If the grid voltage is permanently within the permissible range and this message is still displayed, contact the Service.

11.1.7 Event 206**⚠ QUALIFIED PERSON****Event message:**

- System incident

Explanation:

The utility grid has been disconnected, the AC cable is damaged or the grid voltage at the connection point of the inverter is too low. The inverter has disconnected from the utility grid.

Corrective measures:

- Ensure that the miniature circuit breaker is switched on.
- Ensure that the AC cable is not damaged and that it is connected correctly.
- Ensure that the country data set has been configured correctly.
- Check whether the grid voltage at the connection point of the inverter is permanently in the permissible range.

If the grid voltage is outside the permissible range due to local grid conditions, contact the grid operator. The grid operator must agree with an adjustment of the voltage at the feed-in point or with a change of the monitored operating limits.

If the grid voltage is permanently within the permissible range and this message is still displayed, contact the Service.

11.1.8 Event 301**⚠ QUALIFIED PERSON****Event message:**

- System incident

Explanation:

The ten-minute average value of the grid voltage is no longer within the permissible range. The grid voltage or grid impedance at the connection point is too high. The inverter disconnects from the utility grid to maintain power quality.

Corrective measures:

- During the feed-in operation, check whether the grid voltage at the connection point of the inverter is permanently in the permissible range.

If the grid voltage is outside the permissible range due to local grid conditions, contact the grid operator. The grid operator must agree with an adjustment of the voltage at the feed-in point or with a change of the monitored operating limits.

If the grid voltage is permanently within the permissible range and this message is still displayed, contact the Service.

11.1.9 Event 302**⚠ QUALIFIED PERSON****Event message:**

- Active power limit AC voltage

Explanation:

The inverter has reduced its power due to a too-high grid voltage to ensure grid stability.

Corrective measures:

- If possible, check the grid voltage and observe how often fluctuations occur. If fluctuations occur frequently and this message is displayed often, contact the grid operator and request approval to change the operating parameters of the inverter. If the grid operator gives his approval, discuss any changes to the operating parameters with the Service.

11.1.10 Event 401

⚠ QUALIFIED PERSON**Event message:**

- System incident

Explanation:

The inverter has disconnected from the utility grid. A stand-alone grid or a very large change in the grid frequency was detected.

Corrective measures:

- Ensure that there is no power failure or work being done on the utility grid and contact a grid operator if necessary.
- Check the grid connection for significant short-term frequency fluctuations.

11.1.11 Event 404

⚠ QUALIFIED PERSON**Event message:**

- System incident

Explanation:

The inverter has disconnected from the utility grid. A stand-alone grid or a very large change in the grid frequency was detected.

Corrective measures:

- Ensure that there is no power failure or work being done on the utility grid and contact a grid operator if necessary.
- Check the grid connection for significant short-term frequency fluctuations.

11.1.12 Event 501

⚠ QUALIFIED PERSON**Event message:**

- System incident

Explanation:

The grid frequency is not within the permissible range. The inverter has disconnected from the utility grid.

Corrective measures:

- If possible, check the grid frequency and observe how often fluctuations occur.
If fluctuations occur frequently and this message is displayed often, contact the grid operator and request approval to change the operating parameters of the inverter.
If the grid operator gives his approval, discuss any changes to the operating parameters with the Service.

11.1.13 Event 507

⚠ QUALIFIED PERSON**Event number:**

- 507

Event message:

- Active power limit AC frequency

Explanation:

The inverter has reduced its power due to a too-high grid frequency to ensure grid stability.

Corrective measures:

- If possible, check the grid frequency and observe how often fluctuations occur. If fluctuations occur frequently and this message is displayed often, contact the grid operator and request approval to change the operating parameters of the inverter. If the grid operator gives his approval, discuss any changes to the operating parameters with the Service.

11.1.14 Event 601

⚠ QUALIFIED PERSON**Event message:**

- System incident

Explanation:

The inverter has detected an excessively high proportion of direct current in the grid current.

Corrective measures:

- Check the grid connection for direct current.
- If this message is displayed frequently, contact the grid operator and check whether the monitoring threshold on the inverter can be raised.

11.1.15 Event 701

QUALIFIED PERSON

Event message:

- Frequency not permitted > Check parameter

Explanation:

The grid frequency is not within the permissible range. The inverter has disconnected from the utility grid.

Corrective measures:

- Check the AC cabling from the inverter to the feed-in meter.
- If possible, check the grid frequency and observe how often fluctuations occur.
If fluctuations occur frequently and this message is displayed often, contact the grid operator and request approval to change the operating parameters of the inverter.
If the grid operator gives his approval, discuss any changes to the operating parameters with the Service.

11.1.16 Event 1001

QUALIFIED PERSON

Event message:

- L / N swapped

Explanation:

Incorrect installation of the L / N connection

Corrective measures:

- Check the AC cabling from the inverter to the feed-in meter.
- Check the AC voltages on the inverter connection.
- If this message is still displayed, contact the Service.

11.1.17 Event 1101

QUALIFIED PERSON

Event message:

- Installation fault > Check connection

Explanation:

A second line conductor is connected to N.

Corrective measures:

- Connect the neutral conductor to N.

11.1.18 Event 1302

QUALIFIED PERSON

Event message:

- Wait for grid voltage
- Grid connection installation error
- Check grid and fuses

Explanation:

L or N not connected.

Corrective measures:

- Ensure that the line conductors are connected.
- Ensure that the miniature circuit breaker is switched on.
- Ensure that the AC cable is not damaged and that it is connected correctly.

11.1.19 Event 1501

QUALIFIED PERSON

Event message:

- Reconnection fault grid

Explanation:

The changed country data set or the value of a parameter you have set does not correspond to the local requirements. The inverter cannot connect to the utility grid.

Corrective measures:

- Ensure that the country data set has been configured correctly. To do this, select the parameter **Set country standard** and check the value.

11.1.20 Event 3302

QUALIFIED PERSON

Event message:

- Unstable operation

Explanation:

There is not enough power at the DC input of the inverter for stable operation. The inverter cannot connect to the utility grid.

Corrective measures:

- Ensure that the PV array is dimensioned correctly.
- Ensure that the PV array is not covered by snow or otherwise shaded.

- Ensure that the PV array is free of defects.

11.1.21 Event 3401

QUALIFIED PERSON

Event message:

- DC overvoltage
- Disconnect generator

Explanation:

Overvoltage at the DC input A. This can destroy the inverter.

This message is signaled additionally by rapid flashing of the LEDs.

Corrective measures:

- **Immediately** disconnect the inverter from all voltage sources.
- Check whether the DC voltage is below the maximum input voltage of the inverter. If the DC voltage is below the maximum input voltage of the inverter, reconnect the DC cables to the inverter.
- If the DC voltage exceeds the maximum input voltage of the inverter, ensure that the PV array has been correctly rated or contact the installer of the PV array.
- If this message is repeated frequently, contact Service.

11.1.22 Event 3402

QUALIFIED PERSON

Event message:

- DC overvoltage
- Disconnect generator

Explanation:

Overvoltage at the DC input B. This can destroy the inverter.

This message is signaled additionally by rapid flashing of the LEDs.

Corrective measures:

- **Immediately** disconnect the inverter from all voltage sources.
- Check whether the DC voltage is below the maximum input voltage of the inverter. If the DC voltage is below the maximum input voltage of the inverter, reconnect the DC cables to the inverter.
- If the DC voltage exceeds the maximum input voltage of the inverter, ensure that the PV array has been correctly rated or contact the installer of the PV array.
- If this message is repeated frequently, contact Service.

11.1.23 Event 3407

QUALIFIED PERSON

Event message:

- DC overvoltage
- Disconnect generator

Explanation:

Overvoltage at the DC input C. This can destroy the inverter.

This message is signaled additionally by rapid flashing of the LEDs.

Corrective measures:

- **Immediately** disconnect the inverter from all voltage sources.
- Check whether the DC voltage is below the maximum input voltage of the inverter. If the DC voltage is below the maximum input voltage of the inverter, reconnect the DC cables to the inverter.
- If the DC voltage exceeds the maximum input voltage of the inverter, ensure that the PV array has been correctly rated or contact the installer of the PV array.
- If this message is repeated frequently, contact Service.

11.1.24 Event 3410

QUALIFIED PERSON

Event message:

- DC overvoltage
- Disconnect generator

Explanation:

Overvoltage at the DC input. This can destroy the inverter.

This message is signaled additionally by rapid flashing of the LEDs.

Corrective measures:

- **Immediately** disconnect the inverter from all voltage sources.
- Check whether the DC voltage is below the maximum input voltage of the inverter. If the DC voltage is below the maximum input voltage of the inverter, reconnect the DC cables to the inverter.
- If the DC voltage exceeds the maximum input voltage of the inverter, ensure that the PV array has been correctly rated or contact the installer of the PV array.
- If this message is repeated frequently, contact Service.

11.1.25 Event 3411

QUALIFIED PERSON

Event message:

- DC overvoltage
- Disconnect generator

Explanation:

Overvoltage at the DC input. This can destroy the inverter.

This message is signaled additionally by rapid flashing of the LEDs.

Corrective measures:

- **Immediately** disconnect the inverter from all voltage sources.
- Check whether the DC voltage is below the maximum input voltage of the inverter. If the DC voltage is below the maximum input voltage of the inverter, reconnect the DC cables to the inverter.
- If the DC voltage exceeds the maximum input voltage of the inverter, ensure that the PV array has been correctly rated or contact the installer of the PV array.
- If this message is repeated frequently, contact Service.

11.1.26 Event 3501

QUALIFIED PERSON

Event number:

- 3501

Event message:

- Insulation failure > Check generator

Explanation:

The inverter has detected a ground fault in the PV array.

Corrective measures:

- Check the PV system for ground faults.

11.1.27 Event 3601

QUALIFIED PERSON

Event message:

- High leakage current
- Check generator

Explanation:

The leakage current of the inverter and the PV module is too high. There is a ground fault, a residual current or a malfunction.

The inverter interrupts feed-in operation immediately after exceeding a threshold. When the fault is eliminated, the inverter automatically reconnects to the utility grid.

Corrective measures:

- Check the PV system for ground faults.

11.1.28 Event 3701

⚠ QUALIFIED PERSON**Event message:**

- Residual current too high
- Check generator

Explanation:

The inverter has detected a residual current through brief grounding of the PV array.

Corrective measures:

- Check the PV system for ground faults.

11.1.29 Event 3901

⚠ QUALIFIED PERSON**Event message:**

- Waiting for DC start conditions
- Start conditions not met

Explanation:

The feed-in conditions for the utility grid are not yet fulfilled.

Corrective measures:

- Ensure that the PV array is not covered by snow or otherwise shaded.
- Wait for higher irradiation.
- If this message is displayed frequently in the morning, increase the voltage limit for starting grid feed-in. Change the parameter **Critical voltage to start feed-in**.
- If this message is displayed frequently with medium irradiation, ensure that the PV array is correctly rated.

11.1.30 Event 3902

QUALIFIED PERSON

Event message:

- Waiting for DC start conditions
- Start conditions not met

Explanation:

The feed-in conditions for the utility grid are not yet fulfilled.

Corrective measures:

- Ensure that the PV array is not covered by snow or otherwise shaded.
- Wait for higher irradiation.
- If this message is displayed frequently in the morning, increase the voltage limit for starting grid feed-in. Change the parameter **Critical voltage to start feed-in**.
- If this message is displayed frequently with medium irradiation, ensure that the PV array is correctly rated.

11.1.31 Event 4301

QUALIFIED PERSON

Event message:

- Serial electric arc in string |s0| detected by AFCI module

Explanation:

The inverter has detected an electric arc. The inverter stops feeding into the utility grid.

Corrective measures:

- Check the PV modules as well as the cabling in the affected string for damage.

11.1.32 Event 6001-6438

QUALIFIED PERSON

Event number:

- 6001-6438

Event message:

- Self-diagnosis
- Device fault

Explanation:

The cause must be determined by the Service.

Corrective measures:

- Contact the Service.

11.1.33 Event 6501

⚠ QUALIFIED PERSON**Event message:**

- Self-diagnosis
- Overtemperature

Explanation:

The inverter has switched off due to excessive temperature.

Corrective measures:

- Clean the cooling fins on the rear of the enclosure and the air ducts on the top using a soft brush.
- Ensure that the inverter has sufficient ventilation.
- Ensure that the inverter is not exposed to direct solar irradiation.
- Ensure the maximum ambient temperature is not exceeded.

11.1.34 Event 6509

⚠ QUALIFIED PERSON**Event message:**

- Self-diagnosis
- Overtemperature

Explanation:

The inverter has switched off due to excessive temperature.

Corrective measures:

- Clean the cooling fins on the rear of the enclosure and the air ducts on the top using a soft brush.
- Ensure that the inverter has sufficient ventilation.
- Ensure that the inverter is not exposed to direct solar irradiation.
- Ensure the maximum ambient temperature is not exceeded.

11.1.35 Event 6511

⚠ QUALIFIED PERSON**Event message:**

- Overtemperature

Explanation:

An overtemperature has been detected in the choke area.

Corrective measures:

- Clean the cooling fins on the rear of the enclosure and the air ducts on the top using a soft brush.
- Ensure that the inverter has sufficient ventilation.
- Ensure that the inverter is not exposed to direct solar irradiation.

11.1.36 Event 6512

Event message:

- Minimum operating temperature not reached

Explanation:

The inverter will only recommence grid feed-in once the temperature has reached at least -25°C .

11.1.37 Event 6602

⚠ QUALIFIED PERSON**Event message:**

- Overvoltage grid (AF)

Explanation:

The effective value of the grid voltage is above the permitted voltage threshold values for a specified period of time (AF limit).

Corrective measures:

- Check the grid voltage and connection on the inverter.
If the grid voltage lies outside the permissible range due to local grid conditions, ask your grid operator if the voltage can be adjusted at the feed-in point or if it would be acceptable to change the monitored operating limits.

11.1.38 Event 6801

⚠ QUALIFIED PERSON**Event message:**

- Self-diagnosis > Input A defective

Explanation:

Polarity error on the inverter

Corrective measures:

- Check whether a string is connected to input A.

- Contact the Service.

11.1.39 Event 6901

QUALIFIED PERSON

Event message:

- Self-diagnosis > Input B defective

Explanation:

Polarity error on the inverter

Corrective measures:

- Check whether a string is connected to input B.
- Contact the Service.

11.1.40 Event 7001

QUALIFIED PERSON

Event message:

- Fault sensor interior temperature

Explanation:

A temperature sensor in the inverter is defective and the inverter interrupts the feed-in operation. The cause must be determined by the Service.

Corrective measures:

- Contact the Service.

11.1.41 Event 7014

QUALIFIED PERSON

Event message:

- Sensor error step-up converter temperature

Explanation:

Fan constantly on

Corrective measures:

- Contact the Service.

11.1.42 Event 7015

QUALIFIED PERSON

Event message:

- Fault sensor interior temperature

Explanation:

A temperature sensor in the inverter is defective and the inverter interrupts the feed-in operation. The cause must be determined by the Service.

Corrective measures:

- Contact the Service.

11.1.43 Event 7702

QUALIFIED PERSON

Event message:

- Self-diagnosis
- Device fault

Explanation:

The cause must be determined by the Service.

Corrective measures:

- Contact the Service.

11.1.44 Event 7703

QUALIFIED PERSON

Event message:

- Self-diagnosis
- Device fault

Explanation:

The cause must be determined by the Service.

Corrective measures:

- Contact the Service.

11.1.45 Event 7801

QUALIFIED PERSON

Event message:

- Fault overvoltage protector

Explanation:

One or more surge arresters have tripped or one or more surge arresters are not inserted correctly.

Corrective measures:

- Ensure that the surge arrester is inserted correctly.
- If surge arresters have tripped, replace the tripped surge arresters with new surge arresters.

11.1.46 Event 8501

QUALIFIED PERSON

Event message:

- Offset DC current sensor C.

Corrective measures:

- If this message is displayed again, contact the Service.

11.1.47 Event 8708

QUALIFIED PERSON

Event message:

- Timeout in communication for active power limitation

Explanation:

Communication to the system control absent. Depending on the fallback setting, either the last received values will be retained or the active power will be limited to the set percentage value of the inverter nominal power.

Corrective measures:

- Ensure that the connection to the system manager is intact and that no cables are damaged or that no plugs have been pulled.

11.1.48 Event 8709

QUALIFIED PERSON

Event message:

- Timeout in communication for reactive power setpoint

Explanation:

Communication to the system control absent.

Corrective measures:

- Ensure that the connection to the system manager is intact and that no cables are damaged or that no plugs have been pulled.

11.1.49 Event 8710**⚠ QUALIFIED PERSON****Event number:**

- Timeout in communication for cos phi setpoint

Explanation:

Communication to the system control absent.

Corrective measures:

- Ensure that the connection to the system manager is intact and that no cables are damaged or that no plugs have been pulled.

11.1.50 Event 9002**⚠ QUALIFIED PERSON****Event message:**

- SMA Grid Guard code invalid

Explanation:

The SMA Grid Guard code entered is incorrect. The operating parameters are still protected and cannot be changed.

Corrective measures:

- Enter the correct SMA Grid Guard code.

11.1.51 Event 9003**⚠ QUALIFIED PERSON****Event message:**

- Grid parameters locked

Explanation:

Changes to the grid parameters are now blocked. In order to be able to make changes to the grid parameters, from now on you must log in using the SMA Grid Guard code.

Corrective measures:

- Log in as **Installer** and enter the SMA Grid Guard code.

11.1.52 Event 9007

⚠ QUALIFIED PERSON**Event message:**

- Abort self-test

Explanation:

The self-test was terminated.

Corrective measures:

- Ensure that the AC connection is correct.
- Ensure that the country data set has been entered correctly.
- Restart the self-test.

11.1.53 Event 9033

⚠ QUALIFIED PERSON**Event message:**

- Rapid Shutdown was triggered

Explanation:

The inverter detected the triggering of a Rapid Shutdown. The AC side of the inverter was disconnected.

11.1.54 Event 9034

⚠ QUALIFIED PERSON**Event message:**

- Error in Rapid Shutdown System

Explanation:

This message can have the following causes:

- The Rapid Shutdown Function was not correctly configured.
- The PV array could not be correctly disconnected. Voltage can be applied to the DC inputs of the inverter.
- The standby voltage of all PV array disconnect switches of a string is > 30 V.

Corrective measures:

- Check the configuration of the Rapid Shutdown function and ensure that the operating mode selected is selected according to the DC disconnection unit used.

- Check the functionality of the PV array disconnect switches.
- Check the standby voltage of the PV array disconnect switches used and ensure that the standby voltage of all PV array disconnect switches of a string $< 30\text{ V}$.

11.1.55 Event 9035

QUALIFIED PERSON

Event message:

- Rapid Shutdown successfully performed.

Explanation:

The voltage at the DC inputs and at the AC output of the inverter was successfully discharged.

11.1.56 Event 9038

QUALIFIED PERSON

Event message:

- Redundant Rapid Shutdown discharge function not ensured.

Explanation:

The cause must be determined by the Service.

Corrective measures:

- Contact the Service.

11.2 Checking the PV System for Ground Faults

QUALIFIED PERSON

If the red LED is glowing and the event number 3501, 3601 or 3701 is being displayed in the **Results** menu on the inverter user interface, there may be a ground fault present. The electrical insulation from the PV system to ground is defective or insufficient.

DANGER

Danger to life due to electric shock when touching live system components in case of a ground fault

If a ground fault occurs, parts of the system may still be live. Touching live parts and cables results in death or lethal injuries due to electric shock.

- Disconnect the product from voltage sources and ensure it cannot be reconnected before working on the device.
- Only touch the cables of the PV modules on their insulation.
- Do not touch any parts of the substructure or frame of the PV array.
- Do not connect PV strings with ground faults to the inverter.

WARNING

Danger to life due to electric shock from destruction of the measuring device due to overvoltage

Overvoltage can damage a measuring device and result in voltage being present in the enclosure of the measuring device. Touching the live enclosure of the measuring device results in death or lethal injuries due to electric shock.

- Only use measuring devices with a DC input voltage range of 1000 V or higher.

Procedure:

In order to check the PV system for ground faults, perform the following actions in the prescribed order. The exact procedure is described in the following sections.

- Check the PV system for ground faults by measuring the voltage.
- If the voltage measurement was not successful, check the PV system via insulation resistance measurement for ground faults.

Test by Measuring the Voltage

Proceed as follows to check each string in the PV system for ground faults.

Procedure:

1.

DANGER

Danger to life due to high voltages

- Disconnect the inverter from all voltage sources (see Section 9, page 60).
2. Measure the voltage between the positive terminal and the ground potential (PE).
 3. Measure the voltage between the negative terminal and the ground potential (PE).
 4. Measure the voltage between the positive and negative terminals.
 5. If the following results are present at the same time, there is a ground fault in the PV system:
 - All measured voltages are stable.
 - The sum of the two voltages to ground potential is approximately equal to the voltage between the positive and negative terminals.
 6. If a ground fault is present, determine the location of the ground fault via the ratio of the two measured voltages and eliminate the ground fault.
 7. If a definite ground fault cannot be measured and the message is still displayed, measure the insulation resistance.
 8. Reconnect the strings without ground faults to the inverter and recommission the inverter (see inverter installation inverter).



Location of the ground fault

The example shows a ground fault between the second and third PV module.

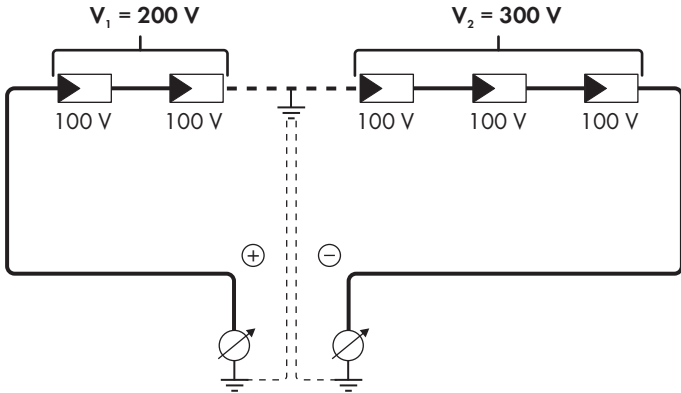

Test by Measuring the Insulation Resistance

If the voltage measurement does not provide sufficient evidence of a ground fault, the insulation resistance measurement can provide more exact results.

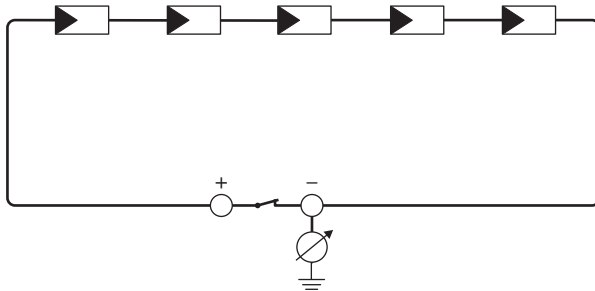

Figure 15: Schematic diagram of the measurement

i Calculating the insulation resistance

The expected total resistance of the PV system or of an individual string can be calculated using the following formula:

$$\frac{1}{R_{\text{total}}} = \frac{1}{R_1} + \frac{1}{R_2} + \frac{1}{R_3} + \dots$$

The exact insulation resistance of a PV module can be obtained from the module manufacturer or the datasheet.

For the resistance of a PV module an average value can be assumed: for thin-film PV modules approximately 40 MOhm and for polycrystalline and monocrystalline PV modules approximately 50 MOhm per PV module (for further information on calculating the insulation resistance see the Technical Information "Insulation Resistance (Riso) of Non-Galvanically Isolated PV Systems" at www.SMA-Solar.com).

Required devices:

- Suitable device for safe disconnection and short-circuiting
- Measuring device for insulation resistance

i Device required for safe disconnection and short-circuiting of the PV array

The insulation resistance can only be measured with a suitable device for safe disconnection and short-circuiting of the PV array. If no suitable device is available, the insulation measurement must not be carried out.

Procedure:

1. Calculate the expected insulation resistance per string.

- 2.

⚠ DANGER

Danger to life due to high voltages

- Disconnect the inverter from all voltage sources (see Section 9, page 60).

3. Install the short circuit device.
4. Connect the measuring device for insulation resistance.
5. Short-circuit the first string.
6. Set the test voltage. The test voltage should be as close as possible to the maximum system voltage of the PV modules but must not exceed it (see datasheet of the PV modules).
7. Measure the insulation resistance.
8. Eliminate the short circuit.
9. Measure the remaining strings in the same manner.
 - If the insulation resistance of a string deviates considerably from the theoretically calculated value, there is a ground fault present in that string.
10. Reconnect to the inverter only those strings from which the ground fault has been eliminated.
11. Reconnect all other strings to the inverter.

12. Recommission the inverter.
13. If the inverter still displays an insulation error, contact the Service (see Section 15, page 97).
The PV modules might not be suitable for the inverter in the present quantity.

11.3 Resetting the Operation Inhibition after Detection of an Arc Fault

QUALIFIED PERSON

If the red LED is glowing and the event number **4301** is shown in the event list on the user interface of the inverter, the inverter has detected an electric arc and interrupts feed-in operation.

Procedure:

1. Disconnect the inverter from all voltage sources (see Section 9, page 60).
 2. Ensure that the PV modules, the connected DC cables and the terminal block for the DC connection are not defective.
 3. Repair or replace defective PV modules, DC cables or terminal block for the DC connection.
 4. Recommission the inverter (see Section 7.2, page 51).
 5. Open the user interface (see Section 8.1, page 54).
 6. Log into the user interface.
 7. To reset the operation inhibition, select the parameter **Reset operating data** or **Parameter.Operation.ValRstIstl** and set it to **Execute all available functions**.
- This effects resetting of the operation inhibition and the inverter will start feeding in again.

12 Decommissioning the Inverter

QUALIFIED PERSON

To decommission the inverter completely upon completion of its service life, proceed as described in this Section.

CAUTION

Risk of injury due to weight of product

Injuries may result if the product is lifted incorrectly or dropped while being transported or mounted.

- Transport and lift the product carefully. Take the weight of the product into account.
- Use the carrying handles or hoist when transporting the product. To attach the hoist system, eye bolts must be screwed into the threads provided, which are located on the right and left of the product's mounting lugs.
- Wear suitable personal protective equipment for all work on the product.

Procedure:

1. Disconnect the inverter from all voltage sources (see Section 9, page 60).

2.

CAUTION

Risk of burns due to hot enclosure parts

- Wait 30 minutes for the enclosure to cool down.

3. Remove the AC cable from the inverter. Press the locking levers all the way upward and pull the conductors out of the terminal block for the AC cable.

4. Press down the locking levers of the terminal block for the AC cable.

5. If additional grounding is connected, remove it.

6. If the multifunction relay is used, remove the connection cable from the inverter.

7. If other cables (e.g. network cables or signal cables) are connected, remove them from the inverter.

8. If a module is plugged in, remove it from the inverter.

9. Close the enclosure lid of the inverter.

10. If the inverter is protected against theft, open the padlock and remove it.

11. Unscrew the two M5x14 screws protecting the inverter from being lifted off with a screwdriver (TX25).

12. Remove the inverter by lifting it up and off the wall mounting bracket.

13. If the inverter is to be stored or shipped in packaging, pack the inverter. Use the original packaging or packaging that is suitable for the weight and dimensions of the inverter.

14. Dispose of the inverter in accordance with the locally applicable disposal regulations for electronic waste.

13 Technical Data

DC Input

	STP 12-50	STP 15-50	STP 20-50	STP 25-50
Maximum power of PV array	18000 W _p STC	22500 W _p STC	30000 W _p STC	37500 W _p STC
Maximum input voltage	1000 V	1000 V	1000 V	1000 V
MPP voltage range	210 V to 800 V	260 V to 800 V	345 V to 800 V	430 V to 800 V
Rated input voltage	580 V	580 V	580 V	580 V
Minimum input voltage	150 V	150 V	150 V	150 V
Initial input voltage	188 V	188 V	188 V	188 V
Maximum usable input current per input	24 A	24 A	24 A	24 A
Maximum short-circuit current per input ¹⁾	37.5 A	37.5 A	37.5 A	37.5 A
Maximum reverse current into the PV modules	0 A	0 A	0 A	0 A
Number of independent MPP inputs	3	3	3	3
Strings per MPP input	2	2	2	2
Surge category in accordance with IEC 62109-1	II	II	II	II

AC output

	STP 12-50	STP 15-50	STP 20-50	STP 25-50
Rated power at 230 V, 50 Hz	12000 W	15000 W	20000 W	25000 W

¹⁾ In accordance with IEC 62109-2: $I_{SC,PV}$

	STP 12-50	STP 15-50	STP 20-50	STP 25-50
Maximum apparent power	12000 VA	15000 VA	20000 VA	25000 VA
Rated apparent power	12000 VA	15000 VA	20000 VA	25000 VA
Nominal grid voltage	220 V / 380 V, 230 V / 400 V, 240 V / 415 V	220 V / 380 V, 230 V / 400 V, 240 V / 415 V	220 V / 380 V, 230 V / 400 V, 240 V / 415 V	220 V / 380 V, 230 V / 400 V, 240 V / 415 V
Rated grid voltage	230 V	230 V	230 V	230 V
Voltage range ²⁾	176 V to 275 V / 304 V to 477 V	176 V to 275 V / 304 V to 477 V	176 V to 275 V / 304 V to 477 V	176 V to 275 V / 304 V to 477 V
Rated current at 230 V	17.4 A	21.7 A	29.0 A	36.2 A
Maximum output current	36.6 A	36.6 A	36.6 A	36.6 A
Maximum output current under fault conditions	682.5 A _{peak} / 10 ms	682.5 A _{peak} / 10 ms	682.5 A _{peak} / 10 ms	682.5 A _{peak} / 10 ms
Total harmonic distortion of the output current with total harmonic distortion of the AC voltage <2%, and AC power >50% of the rated power	< 3 %	< 3 %	< 3 %	< 3 %
Inrush current	< 10% of the nominal AC current for a maximum of 10 ms	< 10% of the nominal AC current for a maximum of 10 ms	< 10% of the nominal AC current for a maximum of 10 ms	< 10% of the nominal AC current for a maximum of 10 ms
Rated grid frequency	50 Hz	50 Hz	50 Hz	50 Hz
Grid frequency ²⁾	50 Hz / 60 Hz	50 Hz / 60 Hz	50 Hz / 60 Hz	50 Hz / 60 Hz
Operating range at grid frequency 50 Hz	44 Hz to 56 Hz	44 Hz to 56 Hz	44 Hz to 56 Hz	44 Hz to 56 Hz

²⁾ Depending on the configured country data set

	STP 12-50	STP 15-50	STP 20-50	STP 25-50
Operating range at grid frequency 60 Hz	54 Hz to 66 Hz	54 Hz to 66 Hz	54 Hz to 66 Hz	54 Hz to 66 Hz
Power factor at rated power	1	1	1	1
Displacement to power factor, adjustable	0.0 overexcited to 0.0 underexcited	0.0 overexcited to 0.0 underexcited	0.0 overexcited to 0.0 underexcited	0.0 overexcited to 0.0 underexcited
Feed-in phases	3	3	3	3
Connection phases	3-(N)-PE	3-(N)-PE	3-(N)-PE	3-(N)-PE
Surge category in accordance with IEC 62109-1	III	III	III	III

Efficiency

	STP 12-50	STP 15-50	STP 20-50	STP 25-50
Maximum efficiency, η_{\max}	98.2 %	98.2 %	98.2 %	98.2 %
European weighted efficiency, η_{EU}	97.6 %	97.8 %	97.9 %	98 %

Protective Devices

DC reverse polarity protection	Short-circuit diode
Input-side disconnection point	DC load-break switch ³⁾
DC overvoltage protection	Surge arrester type 1 and 2 or type 2 (optional)
AC short-circuit current capability	Current control
Grid monitoring	SMA Grid Guard 10.0
Maximal output overcurrent protection	50 A
Ground fault monitoring	Insulation monitoring: $R_{\text{iso}} > 100 \text{ k}\Omega$
All-pole sensitive residual-current monitoring unit	Available
SMA ArcFix arc-fault circuit interrupter	Available
Active anti-islanding method	Frequency shift

³⁾ Usage category according to IEC 60947: DC-PV2

Digital inputs

Quantity	6
Input voltage	12 V DC
Maximum cable length	30 m

Digital output (multifunction relay)

Quantity	3
Execution	Potential-free relay contacts
Maximum switching voltage	30 V _{DC}
Maximum switching current	1 A
Minimum switching current	10 mA
Minimum electrical endurance when the maximum switching voltage and maximum switching current are complied with ⁴⁾	100000 switching cycles
Bounce time	5 ms
Reset time	5 ms
Maximum cable length	30 m

Communication

SMA devices	Max. 5 inverters with SMA Speedwire and 1 energy meter, 100 Mbit/s
I/O systems and meters	Ethernet, 10/100 Mbit/s, Modbus TCP

General Data

Width x height x depth, without feet or DC load-break switch	728 mm x 762 mm x 266 mm
Weight	35 kg
Length x width x height of the packaging	800 mm x 880 mm x 400 mm
Transport weight	40.5 kg
Climatic category in accordance with IEC 60721-3-4	4K26
Environmental category	outdoors
Pollution degree of all enclosure parts	2
Operating temperature range	-25 °C to +60 °C

⁴⁾ Corresponds to 20 years at 12 switching operations per day

Max. permissible value for relative humidity (condensing)	100 %
Maximum operating altitude above mean sea level (MSL)	4000 m
Typical noise emission	59 dB(A)
Power loss in night mode	< 5 W
Topology	Transformerless (Non-isolated)
Cooling method	SMA OptiCool
Number of fans	3
Degree of protection for electronics in accordance with IEC 60529	IP65
Protection class in accordance with IEC 62109-1	I
Radio technology	WLAN 802.11 b/g/n
Radio spectrum	2.4 GHz
Maximum transmission power	100 mW
Wi-Fi range in free-field conditions	10 m
Quantity maximum detectable Wi-Fi networks	32
Grid configurations	TN-C, TN-S, TN-C-S, TT (when $V_{N,PE} < 20$ V)

Climatic Conditions

Installation in accordance with IEC 60721-3-4, Class 4K26

Extended temperature range	-25 °C to +60 °C
Extended humidity range	0% to 100%
Threshold for relative humidity, non-condensing	100 %
Extended air pressure range	79.5 kPa to 106 kPa

Transport in accordance with IEC 60721-3-4, Class 2K12

Temperature range	-40 °C to +70 °C
-------------------	------------------

Equipment

DC terminal	SUNCLIX DC connector
AC connection	Spring-cage terminals

Multifunction relay	As standard
DC surge protection devices, type 1 and 2 or type 2	Optional

Torques

Screws for protecting the inverter from being lifted (M5x14)	1.5 Nm
SUNCLIX swivel nut	2 Nm
Screws for additional grounding (TX25)	4 Nm
Enclosure lid screws (TX25)	6 Nm ± 0.5 Nm

Data Storage Capacity

1-minute values	7 days
5-minute values	7 days
15-minute values	30 days
60-minute values	3 years
Event messages	1024 events

14 Accessories

You will find the accessories for your product in the following overview. If required, these can be ordered from SMA Solar Technology AG or your distributor.

Designation	Short designation	SMA order number
DC overvoltage protection elements	DC surge protection devices, type I + II	DC_SPD_KIT7_T1T2
DC overvoltage protection elements	DC surge protection devices, type II	DC_SPD_KIT6-10

15 Contact

If you have technical problems with our products, please contact the SMA Service Line. The following data is required in order to provide you with the necessary assistance:

- Device type
- Serial number
- Firmware version
- Event message
- Mounting location and mounting height
- Type and number of PV modules
- Type of the communication products connected
- Optional equipment, e.g. communication products
- Use the name of the system in Sunny Portal (if available)
- Access data for Sunny Portal (if available)
- Special country-specific settings (if available)
- Information on the ripple control receiver
- Operating mode of the multifunction relay
- Detailed description of the problem

You can find your country's contact information at:



<https://go.sma.de/service>

16 EU Declaration of Conformity

within the scope of the EU directives

- Radio Equipment Directive 2014/53/EU (22.5.2014 L 153/62) (RED)
- Restriction of the use of certain hazardous substances 2011/65/EU (L 174/88, June 8, 2011) and 2015/863/EU (L 137/10, March 31, 2015) (RoHS)



SMA Solar Technology AG confirms herewith that the products described in this document are in compliance with the fundamental requirements and other relevant provisions of the above-mentioned directives. The entire EU Declaration of Conformity can be found at www.SMA-Solar.com.

Radio technology	WLAN 802.11 b/g/n
Radio spectrum	2.4 GHz
Maximum transmission power	100 mW

17 UK Declaration of Conformity

according to the regulations of England, Wales and Scotland

- Electromagnetic Compatibility Regulations 2016 (SI 2016/1091)
- Electrical Equipment (Safety) Regulations 2016 (SI 2016/1101)
- Radio Equipment Regulations 2017 (SI 2017/1206)
- The Restriction of the Use of Certain Hazardous Substances in Electrical and Electronic Equipment Regulations 2012 (SI 2012/3032)



SMA Solar Technology AG confirms herewith that the products described in this document are in compliance with the fundamental requirements and other relevant provisions of the above-mentioned regulations. The entire UK Declaration of Conformity can be found at www.SMA-Solar.com.

Radio technology	WLAN 802.11 b/g/n
Radio spectrum	2.4 GHz
Maximum transmission power	100 mW

SMA Solar UK Ltd.

Countrywide House
 23 West Bar, Banbury
 Oxfordshire, OX16 9SA
 United Kingdom



www.SMA-Solar.com

