

Jinko Solar

Installation manual for

Photovoltaic Module

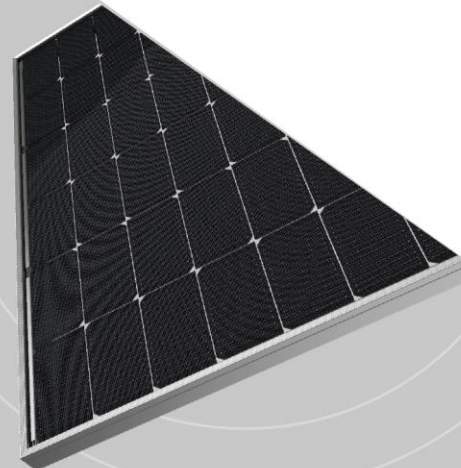

Contents

| | |
|---|----|
| 1. General Information..... | 3 |
| 1.1 Overview | 3 |
| 1.2 Warnings..... | 3 |
| 2. Installation..... | 5 |
| 2.1 Installation Safety | 5 |
| 2.2 Installation Condition..... | 6 |
| 2.2.1 Climate Condition..... | 6 |
| 2.2.2 Site Selection..... | 6 |
| 2.2.3 Tilt Angle Selection | 7 |
| 2.3 Mechanical Installation | 8 |
| 2.3.1 Mounting with bolts | 9 |
| 2.3.2 Mounting with clamps..... | 11 |
| 2.3.2.1 Different methods of clamp installation | 13 |
| 3. Wiring and Connection | 16 |
| 4. Maintenance and Care | 19 |
| 5. Electrical Specification | 20 |
| 6. Disclaimer of Liability | 20 |

1. General Information

1.1 Overview

Thanks for choosing Jinko Solar PV modules (hereafter referred to as “modules”). In order to ensure that the PV modules are installed correctly, please read the following instructions carefully before installing and using the modules.

Please remember that PV modules generate electricity and that certain safety measures must be taken to avoid danger.

The application class of modules: Class II (IEC61730:2016); Class A (IEC61730:2004).

1.2 Warnings



Precautions:

- Modules generate DC electrical energy when exposed to sunlight or other light sources. Improper contact with live parts of the module such as terminals can result in burns, sparks, and lethal shock.
- Front glass is used for the module protection. Broken glass can cause electrical safety hazard (may cause electric shock or fire). These modules cannot be repaired and should be removed and replaced immediately.
- Breakage of the rear glass (in the case of bifacial PV modules) can also lead to the issue of electrical safety. As in the case of monofacial modules, this cannot be repaired and the modules must be disconnected and replaced immediately.
- The table of specifications is measured under standard test conditions (Irradiance 1000W/m², module cell temperature 25°C, air mass=1.5). The current and voltage generated by modules in different environments are different from those listed in the specification table. Therefore, when determining the specifications of the rated voltage, cable capacity, fuse capacity, controller capacity, and other output power related specifications, take the values of 1.25 times the short-circuit current and open-circuit voltage marked on the module as reference, and consult with your inverter/controller supplier for the system configuration design.
- During all deliveries, ensure that the modules are not subjected to big shocks during transportation, which may damage the assembly or cause cracks in the cell of modules.
- When the electrical load is working, do not disconnect components without authorization; if disconnecting the connector is needed, the DC and AC inverters must be turned off first or the main switch of the converter must be cut off.
- When the battery storage system is connected with the PV system, the battery must be installed correctly, so as to protect the operation of the system and ensure the user safety; Follow the battery

manufacturer's instructions for installation, operation, and maintenance.

Prohibitions:

- Do not apply excessive force or objects on the surface of the module, do not impact, and do not twist the frame of the module, which may damage the cells or cause the cells to crack.
- Do not use the module to replace or partly replace roofs and walls of buildings.
- Do not remove any part installed by Jinko Solar or disassemble the module.
- Don't lift up the modules using the attached cables or the junction box.
- Modules (glass, junction boxes, connectors, etc.) shall be protected from long-term exposure to environments containing sulfur, acid, alkaline, etc., which may pose a risk of corrosion to the product, and organic solvents which can destroy ARC coating on the front glass or have a negative impact on the polymers as junction boxes and backsheet.
- The junction box must meet IP68 (IEC60529) requirements, however they must be protected from direct sunlight and water immersion. The interconnection of female-male connectors shall meet the IP68 (IEC60529) requirements. However, it is not recommended to use the connector under water for a long time.
- The junction box connector should not be in contact with oily substances, organic solvents and other corrosive materials, i.e., alcohol, gasoline, lubricants, rust inhibitors, herbicides, to avoid damage to the connector. If the connector is polluted, it needs to be replaced with a new one.
- Do not stand or step on the module like shown in the below pictures. This is prohibited and there is a risk of damaging the module and injuring the user.



- Do not touch live terminals with bare hands. Use insulated tools for electrical connections.
- Artificially concentrated sunlight shall not be directed onto the module. Do not expose the back of the monofacial module directly to sunlight.

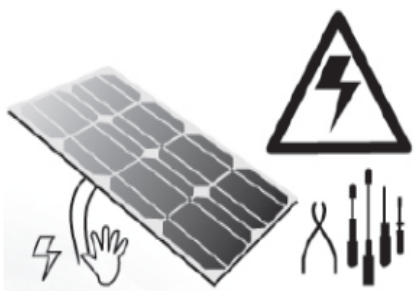

Use insulated tools for electrical connection



Others:

- The maximum altitude of module installation is 2000m.
- The minimum distance from the seashore is 50m (for more info, please refer to 2.2.3).
- When looking at PV modules with anti-reflection (AR) coating technology, it will be normal to see some cells with a slight color difference at different angles.
- Before the installation of modules, it is recommended to keep the modules under rainproof facility to avoid direct exposure to rain and sunlight.
- Meaning of crossed –out wheeled dustbin:

Do not dispose of electrical appliances as unsorted municipal waste, use separate collection facilities.

Contact your local government for information regarding the collection systems available.

If electrical appliances are disposed of in landfills or dumps, hazardous substances can leak into the groundwater and get into the food chain, damaging your health and well-being.

When replacing old appliances with new ones, the retailer is legally obligated to take back your old appliance for disposals at least free of charge.



For more, please contact Jinko or refer to the operation and maintenance guideline.

2. Installation

2.1 Installation Safety

- Always wear safety helmet, insulated gloves and insulated rubber shoes and other protective measures during installation.
- When installing or maintaining the PV system, please do not wear metal rings, watches and other metal products, so as not to cause electric shock danger and damage the modules.
- Keep the module unpacked until installation. Once the modules are removed from the pallet, they shall be installed and connected to the inverter. If they are not installed immediately, protective measures (such as adding rubber joint cover, etc.) should be taken on the connection head.
- Do not touch the PV module with bare hands during installation unless necessary. The glass surface and the frame may be hot. There is a risk of burns and electric shock. Use the standard safety tools and equipment when installing the modules.
- Do not work in rain, snow or windy conditions.
- Due to the risk of electrical shock, do not perform any work if the terminals of the module are wet.

- Use insulated tools and do not use wet tools.
- Only the modules of the same size and the specifications within same range can be connected in series.
- Connect the male and female connectors correctly, check the wiring condition, all wires shall not be detached from the modules, and secure the wires with cable ties so that the wires do not scratch or squeeze the backsheet of the modules.
- Do not touch the junction box or the connectors with bare hands during installation or under sunlight, regardless if the module is connected to or disconnected from the system.
- Do not drill holes in the frame without authorization from Jinko, which may cause corrosion or other negative effects to the module.
- When installing modules on roof mounted structures, please try to follow the “from top to bottom” and “from left to right” principles.
- Thermal expansion and cold contraction effect occurs on the modules. During installation, the interval between two adjacent modules is recommended $\geq 10\text{mm}$. The minimum clearance between two adjacent dual-glass modules is recommended $\geq 20\text{mm}$; If there are special requirements, please confirm with Jinko before installation;
- For roof-top installations, the minimum recommended distance between modules and roof is 10cm.
- During the installation, as for module removal, maintenance and any other related processes, it is recommended that the force applied between the cable and the connector, and the cable and the junction box to be no more than 60N.
- For rooftop installation, it is recommended to reserve walkways for the ease of cleaning, repair and maintenance.

2.2 Installation Condition

2.2.1 Climate Condition

The recommended weather conditions for installing modules are:

- a) Humidity: $< 85\% \text{ RH}$
- b) Ambient air temperature range: -40°C to $+ 40^{\circ}\text{C}$
- c) Limit working ambient temperature range: -40°C to $+ 70^{\circ}\text{C}$

2.2.2 Site Selection

In most applications, Jinko solar PV modules shall be installed in a location where they can receive maximum sunlight throughout the year. In the Northern Hemisphere, the module should typically face south, and in the Southern Hemisphere, the modules should typically face north. Modules facing 30

degrees away from due South (or due North) will lose approximately 10 to 15 percent of their power output. If the module faces 60 degrees away from due South (or due North), the power loss will be 20 to 30 percent. Refer to the longitude and latitude of the location to determine the optimal azimuth of the module.

When choosing a site, avoid trees, buildings or obstructions that could create shadows on the modules. Shading causes loss of power output, even though bypass diodes have been installed for the module, shading will affect the optimum performance and safety issue of the PV modules. Operation in permanent shading conditions is not recommended.

Do not install the PV module near open flame or flammable materials.

Do not install the PV module in a location where it would be immersed in water or continually exposed to water from a sprinkler or fountain etc.

The PV modules can be installed at a distance of 50m away from the seashore. In the case when the modules are installed within 50m to 500m distance from the seashore, the connectors shall be protected, i.e. adding dust plugs. After removing the dust plugs, connect the connectors immediately and take other anti-rust measures to prevent rust.

When the modules are installed on roof, the roof must be constructed with a certain fire resistance (please check local regulations). The local building department can be consulted to determine the type of roofing material used. Modules must be separated from the roof by more than 10cm to facilitate air circulation and heat dissipation.

2.2.3 Tilt Angle Selection

The tilt angle of the PV module is measured between the surface of the PV module and a horizontal ground surface (Figure 1). The module generates maximum output power when directly facing the sun.

For standalone systems, the tilt angle of the modules should be selected to optimize the performance based on the season and sunlight. In general, if the module output is adequate when the irradiance is low (i.e., winter), the angle chosen should be adequate during the rest of the year.

For grid-connected systems, modules should be tilted at the angle that the energy production from the modules will be maximized on an annual basis. The Fire Class Rating of a module for roof mounted system shall meet local code requirements in order to

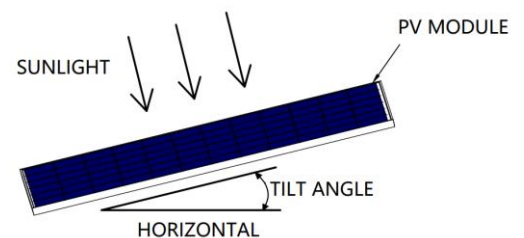

Fig. 1 PV module tilt angle

achieve the specified System Fire Class Rating for a non-BIPV module.

All PV systems have limitations of inclination required to maintain a specific System Fire Class Rating.

2.3 Mechanical Installation

Modules can usually be mounted by using the following methods: bolts and clamps.

*** Note:**

- 1) All installation methods herein are only for reference, and they are based on the test results from third-party tests and Jinko internal tests;
- 2) Jinko solar will not provide related mounting accessories, the system installer or trained professional personnel must be responsible for the PV system's design, installation, and mechanical load calculation and system security.
- 3) Before installation, the following items shall be addressed:
 - a) Visually check the module for any damage. Clean the module if any dirt or residue remains;
 - b) Check if module serial number stickers match.
- 4) The maximum loads that different types of modules can withstand on the front side and back side are dependent on installation methods, which can be referred to Table 1 and Table 4. If there is heavy snow and strong wind on the module installation site, take special protection to meet the actual requirements.

Note: Maximum Test Load = 1.5 (Safety factor) x Design load

2.3.1 Mounting with bolts

Install the module on the rack using anti-corrosion bolts, elastic washers and flat washers with sufficient torque to allow the module to be properly secured. The reference value of tightening torque for M8 bolt is 22-30 N*M, and for M6 bolt is 9-12 N*M. If special mounting system or special installation method is required, please reconfirm with the supplier of the racking system regarding the torque value. See Figure 2 for detailed installation information.

See Figure 3 for the module models with corresponding installation positions for bolt installation (using 4 inner holes), and Table 1 lists different sizes of bolts for different mounting holes

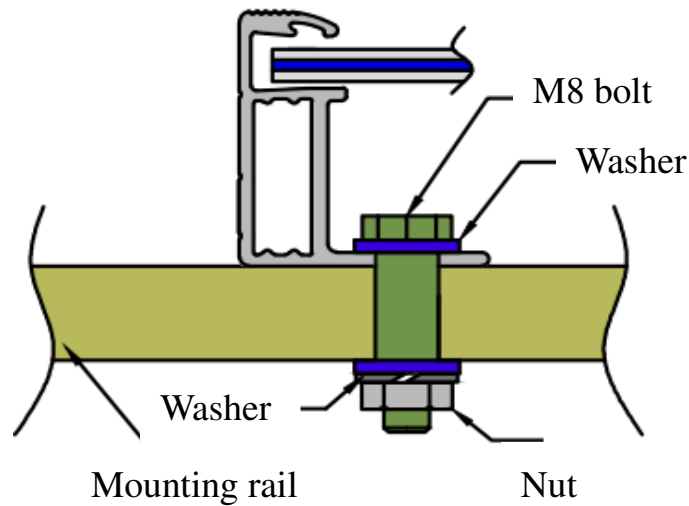

Fig. 2 Mounting with bolts

| Mounting hole (mm) | Bolt size |
|--------------------|-----------|
| 14 x 9 | M8 |
| 10 x 7 | M6 |

Table 1 Bolts for different mounting holes

2.3.1.1 Different installation methods using bolts

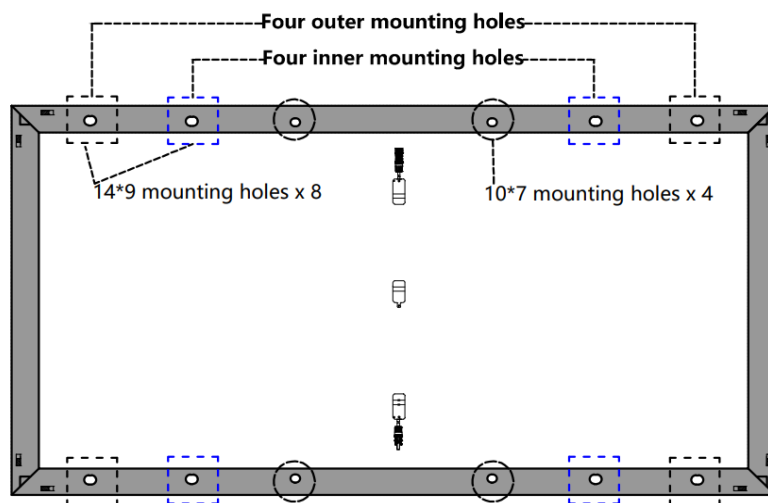

Fig. 3 Installation with bolt (Four inner mounting holes)

| Module type | Bolt installation (Test Load Pa) |
|--------------------|----------------------------------|
| | Four inner mounting holes |
| JKMxxxN-78HL4-(V) | +5400/-2400 |
| JKMxxxN-78HL4-BDV | |
| JKMxxxN-72HL4-(V) | |
| JKMxxxN-72HL4-BDV | |
| JKMxxxN-60HL4-(V) | |
| JKMxxxN-60HL4R-(V) | |
| JKMxxxN-54HL4-(V) | |
| JKMxxxN-54HL4-B | |
| JKMxxxN-54HL4R-(V) | |
| JKMxxxN-54HL4R-B | |
| JKMxxxN-6RL3-(V) | |
| JKMxxxN-6RL3-B | |
| JKMxxxN-6TL3-(V) | |
| JKMxxxN-6TL3-B | |
| JKMxxxM-72HL4-BDVP | |
| JKMxxxM-72HL4-(V) | |
| JKMxxxM-60HL4-(V) | |
| JKMxxxM-54HL4-(V) | |
| JKMxxxM-7RL3-(V) | |

Table 2 Test loads under bolt installation methods for different module types

2.3.2 Mounting with clamps

The clamps used for installation should not come into contact with the front glass and must not deform the frame. Make sure that shadow is not created on modules by the clamps. The module frame is not to be modified under any circumstances. When choosing this installation method of clamp-mounting, please be sure to use at least four clamps on each module. Different locations of clamps determine the maximum load resistance that modules are able to bear. Fig.6 – Fig.14 show different installation methods with different installation locations of clamps. Depending on the local wind and snow loads, if excessive pressure load is expected, additional clamps or support would be required to ensure the module can bear the load. The applied torque value should be big enough to securely fix the modules (Please consult with the mounting structure supplier for the specific torque value). As shown in Fig.4, the length and width of the module are represented by a and b , the distance between the installation position of the long-side fixture and the edge is represented by c . The minimum length of a is 50mm, and the minimum width of d that is the contact width between clamp and frame is 8mm. The distance between the installation position of the short-side clamp and the edge is represented by S in Fig. 7 – Fig. 9.

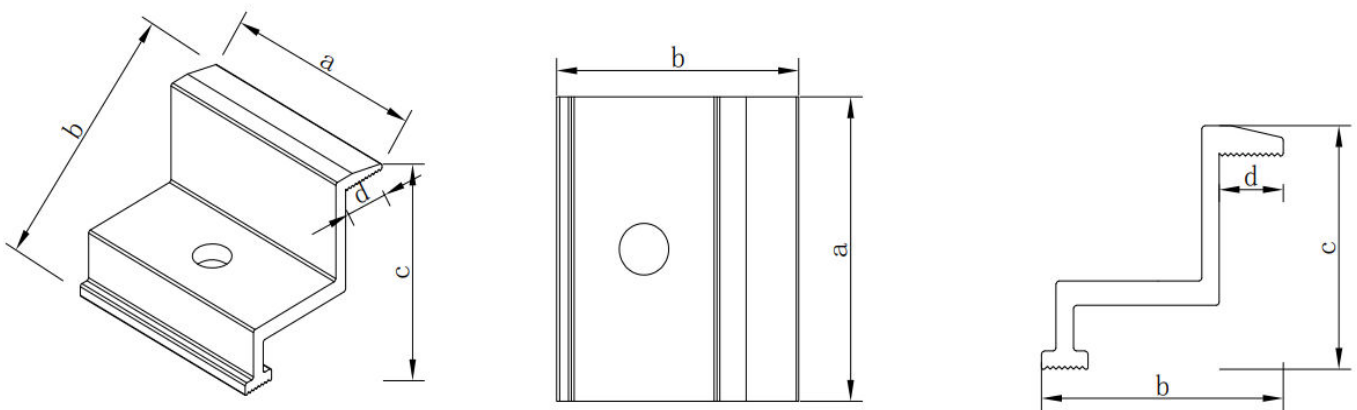

Fig. 4 Clamp

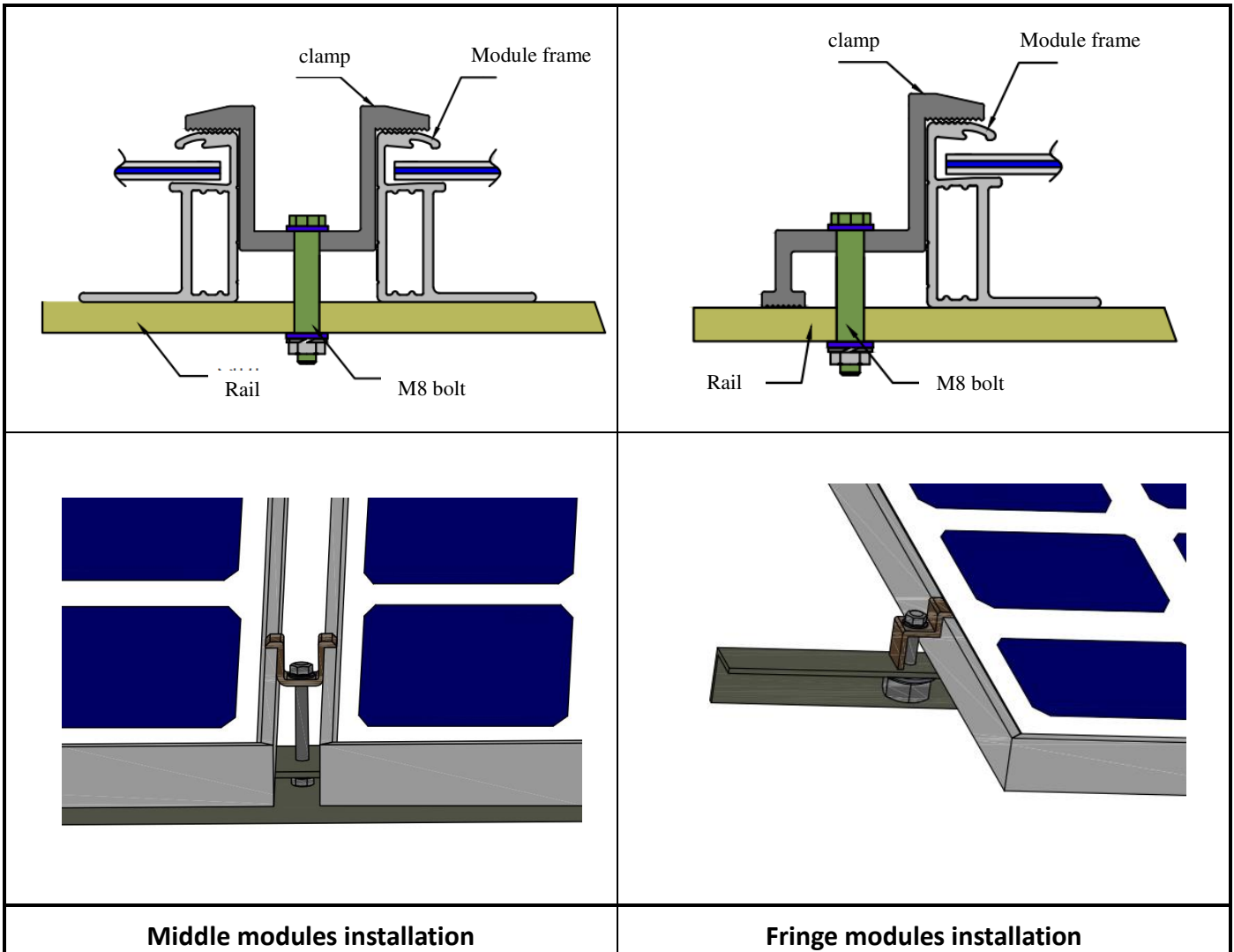

Fig. 5 PV module installed at the side with Clamp mounting

2.3.2.1 Different methods of clamp installation

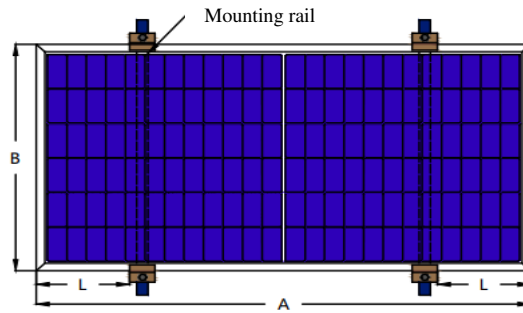

Fig. 6

Long side clamp installation

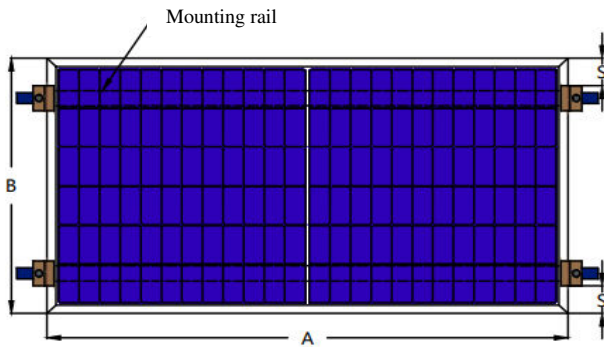

Fig. 7

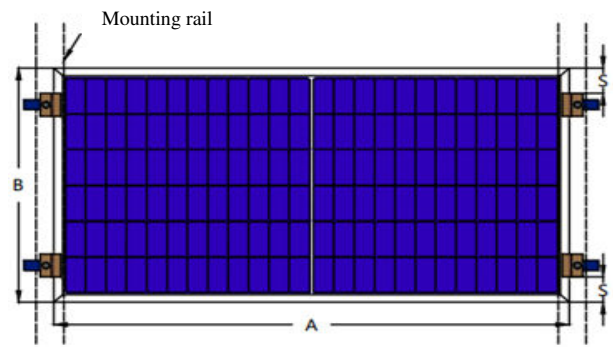

Fig. 8

Short side clamp installation

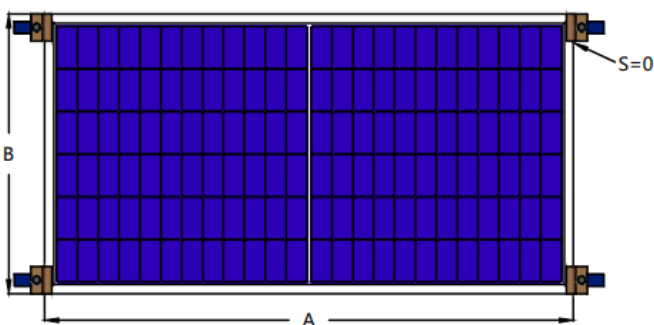

Fig. 9

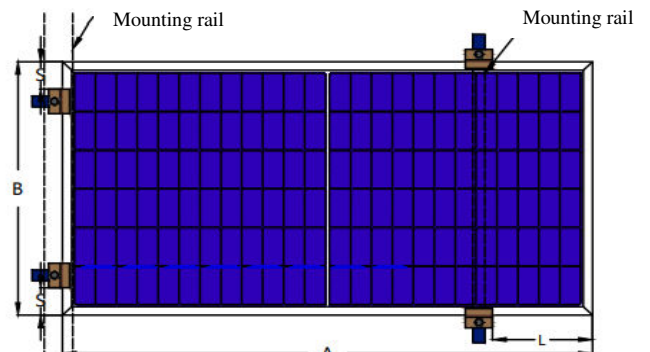

Fig. 10

Corner clamp installation

Long & short side clamp installation

Table 3 Clamp Installation

2.3.2.2 Mechanical loads for different clamp installation

| The installation position under different installation methods for different module types | Clamp installation on long side (+5400, - 2400) L in Fig. 6 | | Clamp installation on short side (± 1600) S in Fig. 7, 8 | Corner clamping (± 1600) Fig. 9 |
|---|--|----------------|---|--|
| | 30 | 35 | 30 | 30 |
| JKMxxxN-54HL4-(V) JKMxxxN-54HL4-B JKMxxxN-54HL4R-(V) JKMxxxN-54HL4R-B JKMxxxM-54HL4-(V) | A/5 \pm 50mm | / | 100~240 | S=0 |
| JKMxxxN-60HL4-(V) JKMxxxN-60HL4R-(V) JKMxxxM-60HL4-(V) | A/5 \pm 50mm | / | 100~240 | S=0 |
| JKMxxxN-6TL3-(V) JKMxxxN-6TL3-B | A/4 \pm 50mm | / | / | / |
| JKMxxxN-6RL3-(V) JKMxxxN-6RL3-B | A/5 \pm 50mm | / | 100~240 | / |
| JKMxxxN-72HL4-(V) JKMxxxM-72HL4-(V) | / | A/5 \pm 50mm | / | / |
| JKMxxxM-7RL3-(V) | / | A/5 \pm 50mm | / | / |
| JKMxxxN-78HL4-(V) | / | A/5~A/4 | / | / |
| JKMxxxM-72HL4-BDVP JKMxxxN-72HL4-BDV | A/4 \pm 50mm | / | / | / |
| JKMxxxN-78HL4-BDV | A/4 \pm 50mm | / | / | / |
| Note | A is the length of the long side of the component. For details, please refer to Datasheet. | | | |

Table 4 Installation dimensions of different module types for clamp mounting

(Note: for the maximum loads that doesn't appear in Table 4 for certain installation methods, and for the other installation methods that doesn't appear in Table 4, please contact Jinko for more details.)

2.3.3 Tracker installation

Jinko modules also have high compatibility with various mainstream tracker systems in the industry. The maximum load that Jinko module can achieve is as listed in Table 5. (For detailed installation drawings, as well as other tracker systems that are not listed in the table, please contact Jinko customer service department for more information.)

| Module type | Tracker system | Installation | Test load (Pa) |
|-----------------------|--|--|----------------|
| JKMxxxN-54HL4-(B)-(V) | ATI 1P | Through bolt clamp 1300/1400mm | +4172/-3200 |
| JKMxxxM-7RL3-TV/V | ATI 1P | Hi-rise clamp 400mm | ±2100 |
| | | Through bolt clamp 1300/1400mm | ±3600 |
| JKMxxxM-7RL3-(V) | NEXTracker 1P | 400mm hole distance | ±1600 |
| JKMxxxM-7RL3-BDVP | | | |
| JKMxxxM-72HL4-(V) | | | |
| JKMxxxM-72HL4-TV | | | |
| JKMxxxN-72HL4-(V) | | | |
| JKMxxxM-72HL4-BDVP | ATI V3 | LMM clamp 600mm | ±2400 |
| | | LMM clamp 850mm | ±2500 |
| | | Through bolt clamp 1300/1400mm | ±3300 |
| | | Hi-rise clamp 300mm | ±1200 |
| | | Hi-rise clamp 400mm | ±1500 |
| | PVH AXDUO MNL+1P | Short rail 60x428 Hole spacing 1086mm Length fixation 400mm | ±1400 |
| | PVH MNL+2P MNL2V | Long rail 80x3845 Hole spacing 1086mm Length fixation 1400mm | +2600/-742 |
| | PVH AXDUO MNL+1P | Short rail 60x428 Hole spacing 1086mm Length fixation 400mm | ±1800 |
| PVH AXDUO MNL+1P | Long rail 60x1128 Hole spacing 1086mm Length fixation 1100mm | ±2400 | |

| | | | |
|--------------------|------------------|--|------------|
| | NEXTracker 1P | 400mm hole distance | ±1600 |
| JKMxxxM-72HL4-TV/V | PVH AXDUO MNL+1P | Short rail 60x428 Hole spacing 1086mm Length fixation 400mm | ±1400 |
| | PVH MNL+2P MNL2V | Long rail 80x3845 Hole spacing 1086mm Length fixation 1400mm | +2600/-742 |
| | PVH AXDUO MNL+1P | Short rail 60x428 Hole spacing 1086mm Length fixation 400mm | ±1800 |
| | PVH AXDUO MNL+1P | Long rail 60x1128 Hole spacing 1086mm Length fixation 1100mm | ±2400 |
| | NEXTracker 1P | 400mm hole distance | ±1600 |
| JKMxxxN-78HL4-(V) | NEXTracker 1P | 400mm hole distance | ±1600 |

Table 5 Test loads under tracker installation methods for different module types

3. Wiring and Connection

- a) When installing and connecting modules, the foam tube must be removed first, Jinko will not guarantee the safety of products and the consistency of technical parameters if the connecting heads and tools used are not officially specified by Jinko or are not installed according to the official requirements.
- b) PV modules connected in series shall have similar current, (please contact Jinko if there is any concern), and modules must not be connected together to create a voltage higher than the permitted system voltage. The maximum number of modules in series depends on system design and the rating of the inverter used.
- c) The maximum fuse rating value in an array string can be found on product label or product datasheet. The fuse rating value is also corresponding to the maximum reverse current that a module can withstand, i.e. when one string is in shade then the other parallel strings of modules will be loaded by the shaded string and the current will pass through to create a current circuit. Based on the maximum series fuse rating of module and local electrical codes and standards, make sure the modules strings in parallel are protected with the appropriate in-line string fuse.
- d) Open the combiner box of the control system and connect the conductor from the PV arrays to the

combiner box in accordance with the design and local codes and standards. The cross-sectional area and cable connector capacity must satisfy the maximum short-circuit of the PV system (for a single module, it is recommended that the cross-sectional area of cables be 4mm^2 and the rated current of connectors be more than 10A), otherwise cables and connectors will become overheating for large current. Please pay attention that the temperature limit of cables is 90°C .

- e) All module frames and mounting racks must be properly grounded in accordance with local and national electrical codes. Attach the equipment grounding conductor to the module frame using the hole and hardware provided. Note that a stainless-steel star washer is used between the grounding wire and module frame (see Figure 15 below). This washer is used to avoid corrosion due to dissimilar metals. Tighten the screw securely, and the tightening torque shall be big enough so that the grounding wire can not be pulled off by hands. Follow the installer's guidance for the grounding installation.

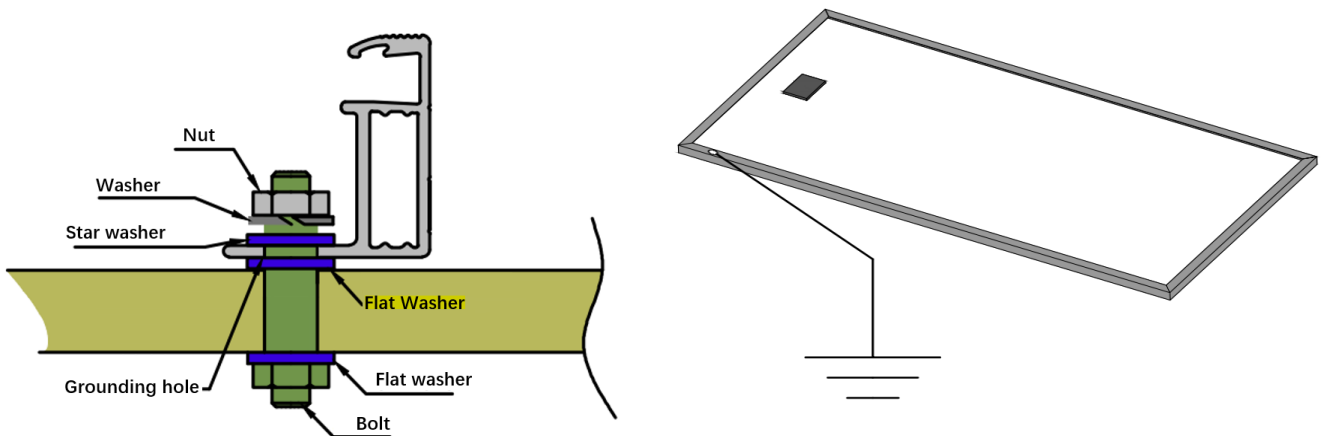

Fig. 11 Ground connection of PV modules

- f) Follow the requirements of applicable local and national electrical codes.
- g) Modules contain factory-installed bypass diodes. If modules are incorrectly connected to each other, the bypass diodes, cable or junction boxes may be damaged.
- h) The length of the junction box shall be determined according to the component specifications and the customer's design proposal. As shown in Figure 16 below, consider the length of the lead wire before designing the wiring.



Fig. 12 (1) The full-cell module junction box

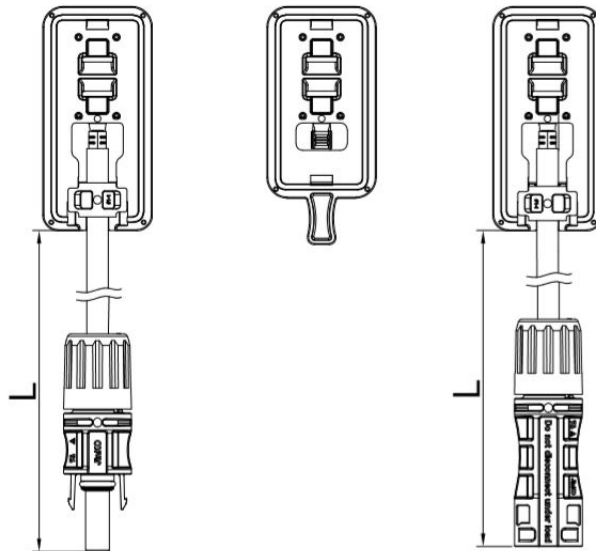

Fig. 12 (2) The half-cut cell module/ split junction box

- i) If modules are connected in series, the total voltage is equal to the sum of individual voltages. The recommended system voltage is as below,

$$\text{System voltage} \geq N \cdot \text{Voc} [1 + \text{TCVoc} \cdot (\text{Tmin} - 25)]$$

If the modules are connected in parallel, the recommended number of modules in parallel is:

$$\text{maximum series fuse rating} / \text{Isc} + 1$$

Where

N module numbers in series

Voc Open circuit voltage (refer to product label or data sheet)

TCVoc Temperature coefficient of open circuit voltage (refer to product label or data sheet)

Tmin Minimum ambient temperature

- j) For floating projects, please contact local technical support.
 k) Connectors and bypass diodes from different manufacturers should not be mated together. If such replacement is needed, please contact Jinko Solar.

4. Maintenance and Care

It is required to perform regular inspection and maintenance of the modules, especially during the warranty period. To ensure optimum module performance, Jinko recommends the following maintenance measures:

4.1 Visual Inspection

Inspect the modules visually to find if there are any visual defects, if there are, the following items should be evaluated:

- a) If the modules are observed having slight cell color differences at different angles, this is a normal phenomenon for modules with anti-reflection coating technology. If the colors are within the cell, please consult Jinko for further analysis.
- b) Whether the glass is broken.
- c) No sharp objects are in contact with the PV module surfaces.
- d) The PV modules are not shaded by unwanted obstacles or foreign material.
- e) Corrosion along the cells' busbar. The corrosion is caused by moisture intrusion through the module back sheet. Check the back sheet for damage.
- f) Check whether the back sheet is burnt.
- g) Check if screws and mounting accessories are tight, adjust and tighten as necessary.

For more please refer to the Operation and Maintenance Manual.

4.2 Cleaning

- a) A buildup of dust or dirt on the module front face will result in a decreased energy output. Clean the module preferably once per annum, more frequently in dusty conditions, using soft cloth dry or damp. Water with high mineral content may leave deposits on the glass surface and is not recommended. It is recommended to use neutral water of the PH value ranging from 6.5 to 8.5 to clean the glass, so as not to cause damage to the glass coating layer;
- b) Never use abrasive material under any circumstances;
- c) In order to reduce the potential for electrical and thermal shock, Jinko recommends to clean PV modules during early morning or late afternoon hours when solar irradiation is low and the modules are cooler, especially in regions with hot temperatures;
- d) Never attempt to clean PV module with broken glass or other signs of exposed wiring, as this presents a shock hazard;
- e) Never use chemicals when cleaning modules as this may affect the module warranty and energy yield. For the environment with extreme climate, please contact Jinko after-sales department for

specific requirement if needed;

- f) For single-side module, backsheet cleaning is not necessary; for dual-glass module, cleaning the module backside regularly when necessary, and follow the requirements in 4.2 a) – e). Please wear insulated gloves and pay special attention to the cables and electrical connections during the backside cleaning.

4.3 Inspection of Connector and Cable

It's recommended to implement the following preventive maintenance every 6 months:

- a) Check the sealing gels of the junction box for any damage.
- b) Examine the modules for signs of deterioration. Check all wiring for possible rodent damage, weathering and that all connections are tight and corrosion free. Check the electrical grounding.

5. Electrical Specification

The electrical properties of the components were measured under standard test condition. In some cases, the component may produce a voltage or current value higher or lower than the rated value. For specific electrical performance parameters, refer to the datasheet in the QR code below.

(Note: the tolerance for Voc is $\pm 3\%$, for Isc is $\pm 4\%$ and for Pmp is $\pm 3\%$)



6. Disclaimer of Liability

Because the use of the manual and the conditions or methods of installation, operation, use and maintenance of photovoltaic (PV) product are beyond Jinko's control, Jinko does not accept responsibility and expressly disclaims liability for loss, damage, or expense arising out of or in any way connected with such installation, operation, use or maintenance.

No responsibility is assumed by Jinko for any infringement of patents or other rights of third parties, which may result from use of the PV product. NO license is granted by implication or otherwise under

any patent or patent rights.

The information in this manual is based on Jinko's knowledge and experience and is believed to be reliable, but such information including product specification (without limitations) and suggestions do not constitute a warranty, expresses or implied. Jinko reserves the right to change the manual, the PV produce, the specifications, or product information sheets without prior notice.

Global Sales & Marketing Center

Jinko Building #99 Shouyang Road,
Jingan District, Shanghai, China
Postcode: 200027
Tel:+86 21 5183 8777
Fax:+86 21 5180 8600

Jiangxi Manufacture Base

Shangrao EconomicDevelopment
Zone, Jiangxi Province, China
Postcode: 334100
Tel:+86 793 858 8188
Fax:+86 793 846 1152

Zhejiang Manufacture Base

No.58 Yuanxi Road, Haining Yuanhua
Industrial Park, Zhejiang Province, China
Postcode: 314416
Tel:+86 573 8798 5678
Fax:+86 573 8787 1070